

# **PRO LINK** **SUPPLY**

## General Information



## General Information

### **FOUR CONVENIENT LOCATIONS to serve you located at:**

ProLink Supply Ltd.  
23416 River Road  
Maple Ridge, B.C. V2W 187  
mapleridge@prolinksupply.com  
(604) 466-8839

ProLink Supply Inc.  
8100 Tacoma Mall Blvd  
Tacoma, Washington 98499  
sales@prolinksupply.com  
(253) 244-7082

ProLink Idaho LLC  
1412 Freedom Ave Ste B  
Caldwell, Idaho 83605  
caldwell@prolinksupply.com  
(208) 776-5465

ProLink Oregon LLC  
1885 16th Street SE  
Salem, Oregon 97302  
salem@prolinksupply.com  
(503) 990-6455

### **HOURS OF OPERATION**

March through November:  
Monday through Friday 7:00 am to 4:30 pm.

December through February:  
Monday through Friday 7:30 am to 4:00 pm.

Times subject to change.

**DELIVERY SERVICE** - ProLink Supply offers quick and convenient delivery service with our own fleet of trucks. Please check your local branch for their delivery schedule.

All deliveries are based on route, weather and truck weight limits. Days and deliveries are subject to change based on these factors. Delivery charges may apply.

(Special deliveries are a possibility, please call and inquire.)

### **DELIVERY AND SHIPPING POLICY**

#### **I) PRICING**

- Materials will be delivered at the prevailing price at time of order unless otherwise quoted.

#### **II) DELIVERY AND FREIGHT CHARGES**

- All orders are shipped freight collect or added to the invoice unless quoted as prepaid.

- All air shipments and orders requiring special handling will be shipped freight collect or added to the invoice.

#### **III) DAMAGE CLAIMS**

- Materials shipped from our warehouse are considered to be the property of the consignee. The responsibility to file a claim belongs to the customer should damage occur. All shipments should be inspected immediately upon arrival and notification of any damage made to the freight carrier.

- ProLink Supply is not responsible for any damage caused by the carrier.

## General Information

---

### IV) RETURN GOODS

- All returned goods are subject to a 20% restock charge.
- All materials must be returned at customer's expense.
- Any materials returned to our warehouse requires prior approval from our sales staff. Please call for a RMA (Return Materials Authorization) prior to returning the materials.
- No product will be accepted for return if:
  - the material is a custom order or custom size.
  - not in resalable condition.
  - material was purchased over 30 days prior to date of return.

### V) C.O.D. SHIPMENTS

- All C.O.D. shipments require payment by certified funds, cash or money order, unless other arrangements have been made with our credit department.
- Any C.O.D. shipment refused by the customer will place the account on cash-in-advance status.
- Paying by credit card may incur a 3% convenience fee.

### VI) WARRANTY

- ProLink Supply will replace any defective material only as warranted by the manufacturer.

### VII) LIMITATION OF CLAIMS

- There are no warranties except that material sold shall be merchantable quality and shall conform to manufacturer specifications. The **BUYER** assumes all risks whatsoever as to the result of the use of materials purchased, whether used singly or in combination with other materials or substances. No claim by **BUYER** of any kind shall be greater in amount than the purchase price of the materials in respect to which damages are claimed. In addition, the **SELLER** shall have no liability whatsoever of incidental, indirect or consequential damages (including, but not limited to, damages for injuries to persons or to property). Failure by **BUYER** to give **SELLER** written notice of claim within 30 days from date of delivery shall constitute a waiver by **BUYER** of all claims in respect to such materials. Any action for breach of this contract (other than for nonpayment of the purchase price) must be commenced within one year after the cause of action has occurred.

### PRODUCTS

- ProLink Supply maintains a complete stock of items in this catalog with the exception of items not normally used in everyday production. ProLink Supply strives to keep all items in stock; however, there are times where demand and manufacturing shortages may delay material fulfillment; these situations are beyond ProLink Supply's control and has no obligation to rush materials via air or priority services to fulfill backorder. Items listed in this catalog that are not normally stocked by ProLink Supply can be ordered from manufacturers' stock on a special order basis.

## General Information

### TERMS OF SALE

- All charges are due at time of delivery unless on approved credit. The terms for credit are **NET 30 days** unless other arrangements have been made with our credit department.

- All charges remaining unpaid by the end of the 2nd month following the month of purchase (30 days past due) will be subject to interest and service charges of 1-1/2% (annual simple interest rate of 18%) and will be subject to withdrawal of credit privileges.

- If any charges remain unpaid after 90 days, open account privileges will be withdrawn until the account is brought to a current status.

### **NO EXCEPTIONS TO THIS POLICY.**

- Any customer placed on C.O.D. status will be required to make satisfactory arrangements for payment of the old balance, as any account over 90 days past due will be placed for collections. We will be flexible in working out a note or other arrangements to clear the old balance.

- Extension of credit after current status has again been reached will be subject to a 30 day grace period with review and approval of the credit department.

- Unused Accounts: Any account that is inactive for a period of one year will be deleted from our system and will require submission of a new credit application to have account reinstated.

- Returned checks: All returned checks are subject to a \$50.00 service charge.

### TERMS OF SALE (CONT.)

- A 3% fee will apply to all account balances paid by credit card outside the terms of your account.

Our credit department periodically informs customers in a past due status of their standing in relation to the above credit policy.

**CREDIT POLICY** - ProLink Supply provides credit terms based on approved credit applications.

Notes: \_\_\_\_\_  
\_\_\_\_\_  
\_\_\_\_\_  
\_\_\_\_\_  
\_\_\_\_\_  
\_\_\_\_\_  
\_\_\_\_\_  
\_\_\_\_\_  
\_\_\_\_\_  
\_\_\_\_\_  
\_\_\_\_\_  
\_\_\_\_\_  
\_\_\_\_\_  
\_\_\_\_\_  
\_\_\_\_\_  
\_\_\_\_\_  
\_\_\_\_\_  
\_\_\_\_\_  
\_\_\_\_\_  
\_\_\_\_\_  
\_\_\_\_\_

## Catalogue Legend

**C.T.O.** - means please call to order that product  
**#/P** - means the number of units per pallet  
**◇** - 'Diamond' or 'Square': the size of spacing between each wire in a spread of chainlink mesh.

'**ZZ**' denotes a variation in a mesh's edge. There are 3 options to purchase:

- KK**=Knuckle & Knuckle edged mesh
- BK**=Barb & Knuckle edged mesh
- BB**=Barb & Barb edged mesh
- C**=The featured mesh comes in compacted rolls

'**YY**' denotes a variation in mesh material:

- G or Ga**: Galvanized
- BK/BL**: Black (Vinyl-Coated)
- GN**: Green (Vinyl-Coated)
- BN**: Brown (Vinyl-Coated)

'**XX**' denotes the colour options for privacy slats:

- GN**: Green
- BL**: Black
- BR**: Brown
- GY**: Grey
- RW**: RedWood
- TA**: Tan
- WH**: White
- SB**: Sky Blue
- RB**: Royal Blue

The same '**XX**' applies for vinyl fence colours:

- DF**: Mesquite
- WH**: White
- TN**: Sand
- DW**: Dark Walnut
- CC**: Coastal Cedar
- WA**: Weathered Aspen
- CY**: Clay
- SG**: Slate Grey
- DS**: Dark Sequoia

'**WW**' specifies a product's material:

- PS**: Pressed Steel
- BL**: Black Powdercoated Steel
- MA**: Malleable
- BM**: Black Malleable
- AL**: Aluminum
- NY**: Nylon
- GI**: Galvanized Iron
- DC**: Die Cast

### OTHER NOTES

All weights are given in pounds except stated otherwise, same with all lengths in either inches or feet.

'Diamond' is synonymous with 'Square': the size of the spacing in between each wire in a spread of chainlink mesh.

Some products occur twice in multiple sections, this is intended to optimize your search.

### TABLE OF CONTENTS

The categories of products are as follows:

- Mesh (Canada)-**MHC**
- Mesh (U.S.A.)-**MHA**
- Privacy Slats-**PRS**
- Pipe (Canada)-**PIC**
- Pipe (U.S.A.)-**PIA**
- Agricultural-**AGR**
- Residential Gates-**RGA**
- Gate Hardware-**HAR**
- Fittings-**FIT**
- Ornamental-**ORN**
- Vinyl-**VIN**
- Wood-**WOO**
- Other Accessories-**ACC**
- Tools-**TOO**

# PROLINK SUPPLY

## Mesh (Canada)

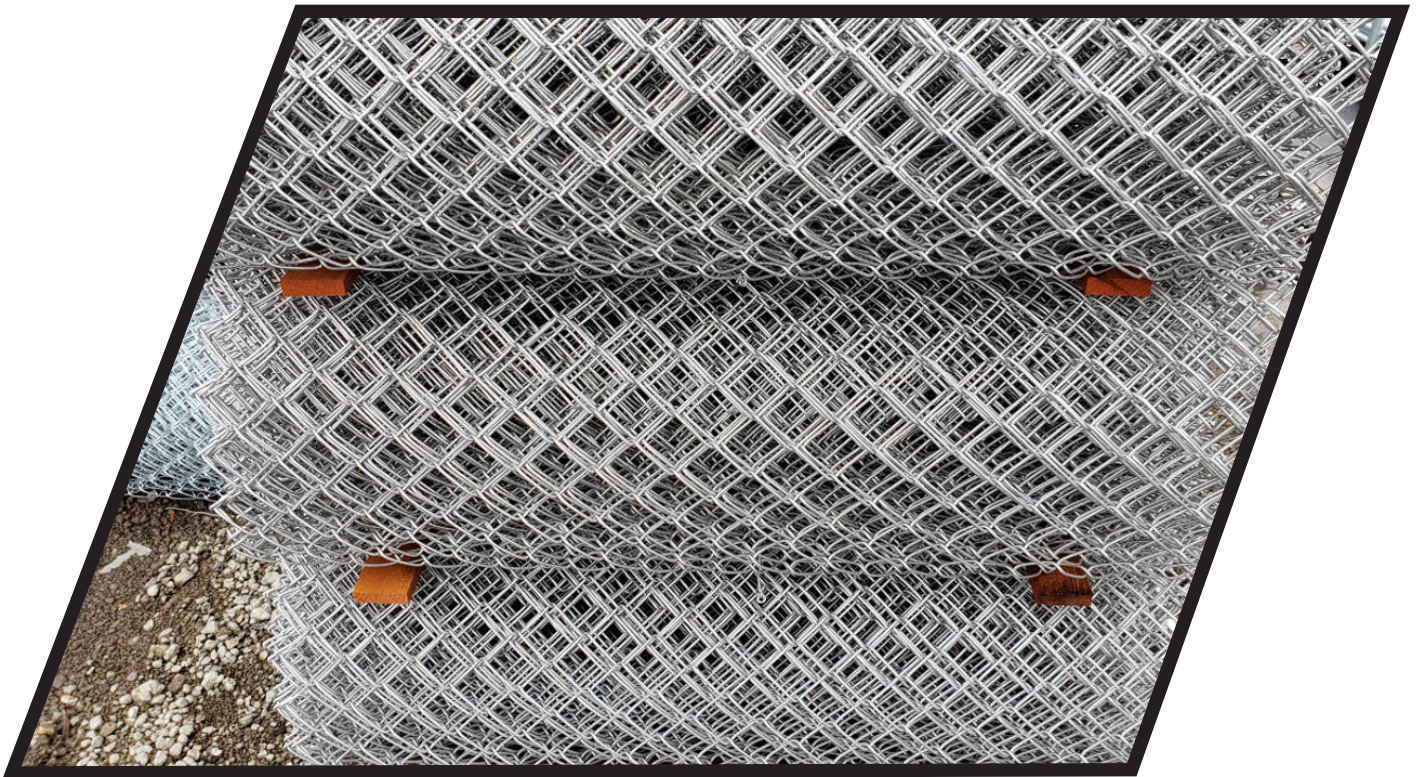

## 11 Gauge Galvanized (.106)

CAD Item #	◇	Edge	Height	Weight/ft	Unit (ft)	#/P
00110-ZZ	2"	KK	36"	1.14 lbs	Roll (50)	9
00111-ZZ	2"	KK	42"	1.33 lbs	Roll (50)	9
00112-ZZ	2"	KK	48"	1.80 lbs	Roll (50)	9
00113-ZZ	2"	KK	60"	2.00 lbs	Roll (50)	9
00114-ZZ	2"	BK, KK, BB	72"	2.85 lbs	Roll (50)	9
00115-ZZ	2"	BK, KK, BB	84"	3.30 lbs	Roll (50)	9
00116-ZZ	2"	BK, KK, BB	96"	3.80 lbs	Roll (50)	9
00118-ZZ	2"	BK, KK, BB	120"	4.05 lbs	Roll (50)	9
00120-ZZ	2"	BK, KK, BB	144"	5.65 lbs	Roll (50)	9

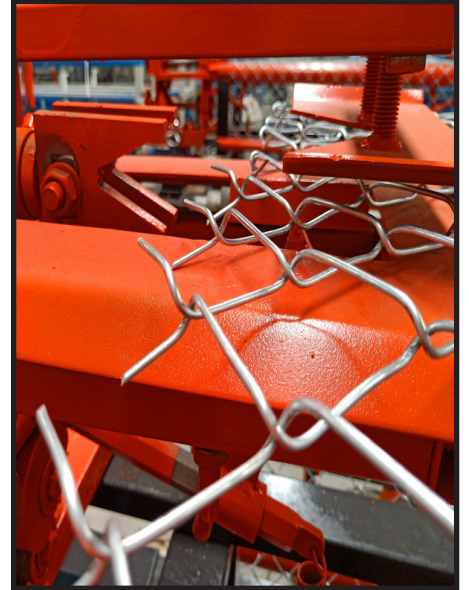

## 9 Gauge Galvanized (.134)

CAD Item #	◇	Edge	Height	Wgt/ft	Unit (ft)	#/P
00200-ZZ	2"	KK	36"	1.70 lbs	Roll (50)	9
00201-ZZ	2"	KK	42"	1.99 lbs	Roll (50)	9
00202-ZZ	2"	KK	48"	2.27 lbs	Roll (50)	9
00202-ZZC	2"	KK	48"	2.27 lbs	Roll (50)	16
00203-ZZ	2"	KK	60"	2.84 lbs	Roll (50)	9
00203-ZZC	2"	KK	60"	2.84 lbs	Roll (50)	16
00204-ZZ	2"	BK,KK,BB	72"	3.41 lbs	Roll (50)	9
00204-ZZC	2"	BK,KK	72"	3.41 lbs	Roll (50)	16
00205-ZZ	2"	BK,KK,BB	84"	3.98 lbs	Roll (50)	9
00206-ZZ	2"	BK,KK,BB	96"	4.54 lbs	Roll (50)	9
00207-ZZ	2"	BK,KK,BB	108"	5.11 lbs	Roll (50)	9
00208-ZZ	2"	BK,KK,BB	120"	5.68 lbs	Roll (50)	9
00210-BK	2"	BK,KK,BB	144"	6.82 lbs	Roll (50)	9
00250-ZZ	1 3/4"	KK	36"	2.26 lbs	Roll (25)	16
00251-ZZ	1 3/4"	KK	42"	2.62 lbs	Roll (25)	16
00252-ZZ	1 3/4"	KK	48"	3.00 lbs	Roll (25)	16
00253-ZZ	1 3/4"	KK	60"	3.76 lbs	Roll (25)	16
00254-ZZ	1 3/4"	BK,KK,BB	72"	4.50 lbs	Roll (25)	16
00255-ZZ	1 3/4"	BK,KK,BB	84"	5.26 lbs	Roll (25)	16
00256-ZZ	1 3/4"	BK,KK,BB	96"	6.00 lbs	Roll (25)	16
00257-ZZ	1 3/4"	BK,KK,BB	108"	6.76 lbs	Roll (25)	16
00258-ZZ	1 3/4"	BK,KK,BB	120"	7.50 lbs	Roll (25)	16
00260-ZZ	1 3/4"	BK,KK,BB	144"	9.00 lbs	Roll (25)	16
00280-KK	1 1/2"	KK	36"	2.61 lbs	Roll (25)	16
00281-KK	1 1/2"	KK	42"	3.12 lbs	Roll (25)	16
00282-KK	1 1/2"	KK	48"	3.56 lbs	Roll (25)	16
00283-KK	1 1/2"	KK	60"	4.46 lbs	Roll (25)	16

CAD Item #	◇	Edge	Height	Wgt/ft	#/P
00284-ZZ	1 1/2"	BK,KK,BB	72"	5.34 lbs	16
00285-ZZ	1 1/2"	BK,KK,BB	84"	6.24 lbs	16
00286-ZZ	1 1/2"	BK,KK,BB	96"	7.12 lbs	16
00287-ZZ	1 1/2"	BK,KK,BB	108"	8.02 lbs	16
00288-ZZ	1 1/2"	BK,KK,BB	120"	9.10 lbs	16
00290-ZZ	1 1/2"	BK,KK,BB	144"	10.68 lbs	16
00310-ZZ	1 1/4"	KK	36"	3.58 lbs	16
00311-ZZ	1 1/4"	KK	42"	4.16 lbs	16
00312-ZZ	1 1/4"	KK	48"	4.76 lbs	16
00313-ZZ	1 1/4"	KK	60"	5.96 lbs	16
00314-ZZ	1 1/4"	BK,KK,BB	72"	7.14 lbs	16
00315-ZZ	1 1/4"	BK,KK,BB	84"	8.34 lbs	16
00316-ZZ	1 1/4"	BK,KK,BB	96"	9.52 lbs	16
00317-ZZ	1 1/4"	BK,KK,BB	108"	10.72 lbs	16
00318-ZZ	1 1/4"	BK,KK,BB	120"	11.90 lbs	16
00320-ZZ	1 1/4"	BK,KK,BB	144"	14.28 lbs	16
00340-ZZ	1"	KK	36"	3.96 lbs	16
00341-ZZ	1"	KK	42"	4.62 lbs	16
00342-ZZ	1"	KK	48"	5.28 lbs	16
00343-ZZ	1"	KK	60"	6.60 lbs	16
00344-BK	1"	BK,KK,BB	72"	7.92 lbs	16
00345-BK	1"	BK,KK,BB	84"	9.24 lbs	16
00346-BK	1"	BK,KK,BB	96"	10.56 lbs	16
00347-BK	1"	BK,KK,BB	108"	11.88 lbs	16
00348-KK	1"	BK,KK,BB	120"	13.20 lbs	16
00350-BB	1"	BK,KK,BB	144"	15.00 lbs	16

Note: All of above come in rolls of 25ft

## 6 Gauge Galvanized (.192)

CAD Item #	◇	Edge	Height	Weight/ft	Unit (ft)	#/P
00600-ZZ	2"	KK	36"	3.64 lbs	Roll (25)	16
00601-ZZ	2"	KK	42"	4.24 lbs	Roll (25)	16
00602-ZZ	2"	KK	48"	4.84 lbs	Roll (25)	16
00603-ZZ	2"	KK	60"	6.06 lbs	Roll (25)	16
00604-ZZ	2"	BK,KK,BB	72"	7.26 lbs	Roll (25)	16
00605-ZZ	2"	BK,KK,BB	84"	8.48 lbs	Roll (25)	16
00606-ZZ	2"	BK,KK,BB	96"	9.68 lbs	Roll (25)	16
00607-ZZ	2"	BK,KK,BB	108"	10.90 lbs	Roll (25)	16
00608-ZZ	2"	BK,KK,BB	120"	12.10 lbs	Roll (25)	16
00610-ZZ	2"	BK,KK,BB	144"	14.52 lbs	Roll (25)	16
00630-ZZ	1 3/4"	KK	36"	4.38 lbs	Roll (25)	16
00631-ZZ	1 3/4"	KK	42"	5.12 lbs	Roll (25)	16
00632-ZZ	1 3/4"	KK	48"	5.84 lbs	Roll (25)	16
00633-ZZ	1 3/4"	KK	60"	7.30 lbs	Roll (25)	16
00634-ZZ	1 3/4"	BK,KK,BB	72"	8.76 lbs	Roll (25)	16
00635-ZZ	1 3/4"	BK,KK,BB	84"	10.20 lbs	Roll (25)	16
00636-ZZ	1 3/4"	BK,KK,BB	96"	11.68 lbs	Roll (25)	16
00637-ZZ	1 3/4"	BK,KK,BB	108"	13.14 lbs	Roll (25)	16
00638-ZZ	1 3/4"	BK,KK,BB	120"	14.60 lbs	Roll (25)	16
00640-ZZ	1 3/4"	BK,KK,BB	144"	17.52 lbs	Roll (25)	16
00660-ZZ	1 1/2"	KK	36"	5.70 lbs	Roll (25)	16
00661-ZZ	1 1/2"	KK	42"	6.65 lbs	Roll (25)	16
00662-ZZ	1 1/2"	KK	48"	7.60 lbs	Roll (25)	16
00663-ZZ	1 1/2"	KK	60"	9.50 lbs	Roll (25)	16
00664-ZZ	1 1/2"	BK,KK,BB	72"	11.40 lbs	Roll (25)	16
00665-ZZ	1 1/2"	BK,KK,BB	84"	13.30 lbs	Roll (25)	16
00666-ZZ	1 1/2"	BK,KK,BB	96"	15.20 lbs	Roll (25)	16
00667-ZZ	1 1/2"	BK,KK,BB	108"	17.10 lbs	Roll (25)	16
00668-ZZ	1 1/2"	BK,KK,BB	120"	22.80 lbs	Roll (25)	16
00670-ZZ	1 1/2"	BK,KK,BB	144"	26.35 lbs	Roll (25)	16



A compacted roll of 9 gauge mesh.

## 9 Gauge Vinyl Extruded - Black

CAD Item #	◇	Edge	Height	Wgt/ft	Unit (ft)	#/P
01000-ZZ	2"	BK, KK, BB	36"	1.20 lbs	Roll (50)	9
01001-ZZ	2"	BK, KK, BB	42"	1.44 lbs	Roll (50)	9
01002-ZZ	2"	BK, KK, BB	48"	1.64 lbs	Roll (50)	9
01002-BLC	2"	BLC	48"	1.64 lbs	Roll (50)	20
01003-ZZ	2"	BK, KK, BB	60"	2.06 lbs	Roll (50)	9
01003-BLC	2"	BLC	60"	2.06 lbs	Roll (50)	20
01004-ZZ	2"	BK, KK, BB	72"	2.46 lbs	Roll (50)	9
01004-BLC	2"	BLC	72"	2.46 lbs	Roll (50)	9
01005-ZZ	2"	BK, KK, BB	84"	3.00 lbs	Roll (50)	9
01006-ZZ	2"	BK, KK, BB	96"	3.28 lbs	Roll (50)	9
01007-ZZ	2"	BK, KK, BB	108"	3.70 lbs	Roll (50)	9
01008-ZZ	2"	BK, KK, BB	120"	4.10 lbs	Roll (50)	9
01010-ZZ	2"	BK, KK, BB	144"	4.92 lbs	Roll (25)	16
01030-ZZ	1 3/4"	BK, KK, BB	36"	1.50 lbs	Roll (25)	16
01031-ZZ	1 3/4"	BK, KK, BB	42"	1.72 lbs	Roll (25)	16
01032-ZZ	1 3/4"	BK, KK, BB	48"	1.96 lbs	Roll (25)	16
01033-ZZ	1 3/4"	BK, KK, BB	60"	2.46 lbs	Roll (25)	16
01034-ZZ	1 3/4"	BK, KK, BB	72"	2.94 lbs	Roll (25)	16
01035-ZZ	1 3/4"	BK, KK, BB	84"	3.50 lbs	Roll (25)	16
01036-ZZ	1 3/4"	BK, KK, BB	96"	3.92 lbs	Roll (25)	16
01037-ZZ	1 3/4"	BK, KK, BB	108"	4.42 lbs	Roll (25)	16
01038-ZZ	1 3/4"	BK, KK, BB	120"	4.70 lbs	Roll (25)	16
01040-ZZ	1 3/4"	BK, KK, BB	144"	4.92 lbs	Roll (25)	16
01060-ZZ	1 1/2"	BK, KK, BB	36"	1.80 lbs	Roll (25)	16
01061-ZZ	1 1/2"	BK, KK, BB	42"	2.10 lbs	Roll (25)	16
01062-ZZ	1 1/2"	BK, KK, BB	48"	2.40 lbs	Roll (25)	16
01063-ZZ	1 1/2"	BK, KK, BB	60"	3.00 lbs	Roll (25)	16
01064-ZZ	1 1/2"	BK, KK, BB	72"	3.60 lbs	Roll (25)	16
01065-ZZ	1 1/2"	BK, KK, BB	84"	5.00 lbs	Roll (25)	16
01066-ZZ	1 1/2"	BK, KK, BB	96"	6.00 lbs	Roll (25)	16

CAD Item #	◇	Edge	Height	Wgt/ft	#/P
01067-ZZ	1 1/2"	BK, KK, BB	108"	6.60 lbs	16
01068-ZZ	1 1/2"	BK, KK, BB	120"	7.00 lbs	16
01070-ZZ	1 1/2"	BK, KK, BB	144"	7.20 lbs	16
01090-ZZ	1 1/4"	BK, KK, BB	36"	2.20 lbs	16
01091-ZZ	1 1/4"	BK, KK, BB	42"	2.62 lbs	16
01092-ZZ	1 1/4"	BK, KK, BB	48"	3.00 lbs	16
01093-ZZ	1 1/4"	BK, KK, BB	60"	3.76 lbs	16
01094-ZZ	1 1/4"	BK, KK, BB	72"	4.50 lbs	16
01095-ZZ	1 1/4"	BK, KK, BB	84"	5.20 lbs	16
01096-ZZ	1 1/4"	BK, KK, BB	96"	6.00 lbs	16
01097-ZZ	1 1/4"	BK, KK, BB	108"	6.76 lbs	16
01098-ZZ	1 1/4"	BK, KK, BB	120"	7.50 lbs	16
01100-ZZ	1 1/4"	BK, KK, BB	144"	9.00 lbs	16
01120-ZZ	1"	BK, KK, BB	36"	2.76 lbs	16
01121-ZZ	1"	BK, KK, BB	42"	3.22 lbs	16
01122-ZZ	1"	BK, KK, BB	48"	3.68 lbs	16
01123-ZZ	1"	BK, KK, BB	60"	4.60 lbs	16
01124-ZZ	1"	BK, KK, BB	72"	5.52 lbs	16
01125-ZZ	1"	BK, KK, BB	84"	6.44 lbs	16
01126-ZZ	1"	BK, KK, BB	96"	7.36 lbs	16
01127-ZZ	1"	BK, KK, BB	108"	8.28 lbs	16
01128-ZZ	1"	BK, KK, BB	120"	9.20 lbs	16
01130-ZZ	1"	BK, KK, BB	144"	11.04 lbs	16

Note: All of above come in rolls of 25ft

## 6 Gauge Vinyl - Black

CAD Item #	◇	Edge	Height	Wgt/ft	#/P
01400-ZZ	2"	BK, KK, BB	36"	2.40 lbs	16
01401-ZZ	2"	BK, KK, BB	42"	2.72 lbs	16
01402-ZZ	2"	BK, KK, BB	48"	3.10 lbs	16
01403-ZZ	2"	BK, KK, BB	60"	3.88 lbs	16
01404-ZZ	2"	BK, KK, BB	72"	4.66 lbs	16
01405-ZZ	2"	BK, KK, BB	84"	5.42 lbs	16
01406-ZZ	2"	BK, KK, BB	96"	6.20 lbs	16
01407-ZZ	2"	BK, KK, BB	108"	6.98 lbs	16
01408-ZZ	2"	BK, KK, BB	120"	7.76 lbs	16
01410-ZZ	2"	BK, KK, BB	144"	9.30 lbs	16
01430-ZZ	1 3/4"	BK, KK, BB	36"	2.40 lbs	16
01431-ZZ	1 3/4"	BK, KK, BB	42"	2.90 lbs	16
01432-ZZ	1 3/4"	BK, KK, BB	48"	3.34 lbs	16
01433-ZZ	1 3/4"	BK, KK, BB	60"	4.16 lbs	16
01434-ZZ	1 3/4"	BK, KK, BB	72"	5.00 lbs	16
01435-ZZ	1 3/4"	BK, KK, BB	84"	5.80 lbs	16
01436-ZZ	1 3/4"	BK, KK, BB	96"	6.66 lbs	16
01437-ZZ	1 3/4"	BK, KK, BB	108"	7.50 lbs	16
01438-ZZ	1 3/4"	BK, KK, BB	120"	8.34 lbs	16
01440-ZZ	1 3/4"	BK, KK, BB	144"	10.00 lbs	16
01460-ZZ	1 1/2"	BK, KK, BB	36"	3.00 lbs	16
01461-ZZ	1 1/2"	BK, KK, BB	42"	3.54 lbs	16
01462-ZZ	1 1/2"	BK, KK, BB	48"	4.04 lbs	16
01463-ZZ	1 1/2"	BK, KK, BB	60"	5.06 lbs	16
01464-ZZ	1 1/2"	BK, KK, BB	72"	6.06 lbs	16
01465-ZZ	1 1/2"	BK, KK, BB	84"	7.07 lbs	16
01466-ZZ	1 1/2"	BK, KK, BB	96"	8.50 lbs	16
01467-ZZ	1 1/2"	BK, KK, BB	108"	9.20 lbs	16
01468-ZZ	1 1/2"	BK, KK, BB	120"	10.00 lbs	16
01470-ZZ	1 1/2"	BK, KK, BB	144"	12.20 lbs	16

CAD Item #	◇	Edge	Height	Wgt/ft	#/P
01490-ZZ	1 1/4"	BK, KK, BB	36"	3.00 lbs	16
01491-ZZ	1 1/4"	BK, KK, BB	42"	4.30 lbs	16
01492-ZZ	1 1/4"	BK, KK, BB	48"	4.88 lbs	16
01493-ZZ	1 1/4"	BK, KK, BB	60"	6.10 lbs	16
01494-ZZ	1 1/4"	BK, KK, BB	72"	7.32 lbs	16
01495-ZZ	1 1/4"	BK, KK, BB	84"	8.50 lbs	16
01496-ZZ	1 1/4"	BK, KK, BB	96"	9.70 lbs	16
01497-ZZ	1 1/4"	BK, KK, BB	108"	10.98 lbs	16
01498-ZZ	1 1/4"	BK, KK, BB	120"	11.00 lbs	16
01500-ZZ	1 1/4"	BK, KK, BB	144"	13.00 lbs	16
01520-ZZ	1"	BK, KK, BB	36"	4.70 lbs	16
01521-ZZ	1"	BK, KK, BB	42"	4.80 lbs	16
01522-ZZ	1"	BK, KK, BB	48"	5.56 lbs	16
01523-ZZ	1"	BK, KK, BB	60"	6.95 lbs	16
01524-ZZ	1"	BK, KK, BB	72"	8.34 lbs	16
01525-ZZ	1"	BK, KK, BB	84"	9.73 lbs	16
01526-ZZ	1"	BK, KK, BB	96"	11.12 lbs	16
01527-ZZ	1"	BK, KK, BB	108"	12.51 lbs	16
01528-ZZ	1"	BK, KK, BB	120"	13.90 lbs	16
01530-ZZ	1"	BK, KK, BB	144"	16.68 lbs	16

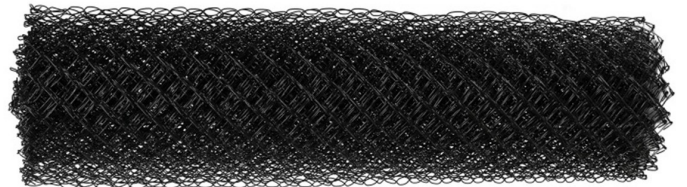

Note: All SKUs come in rolls of 25ft

# **PROLINK** **SUPPLY**

## Mesh (U.S.A.)

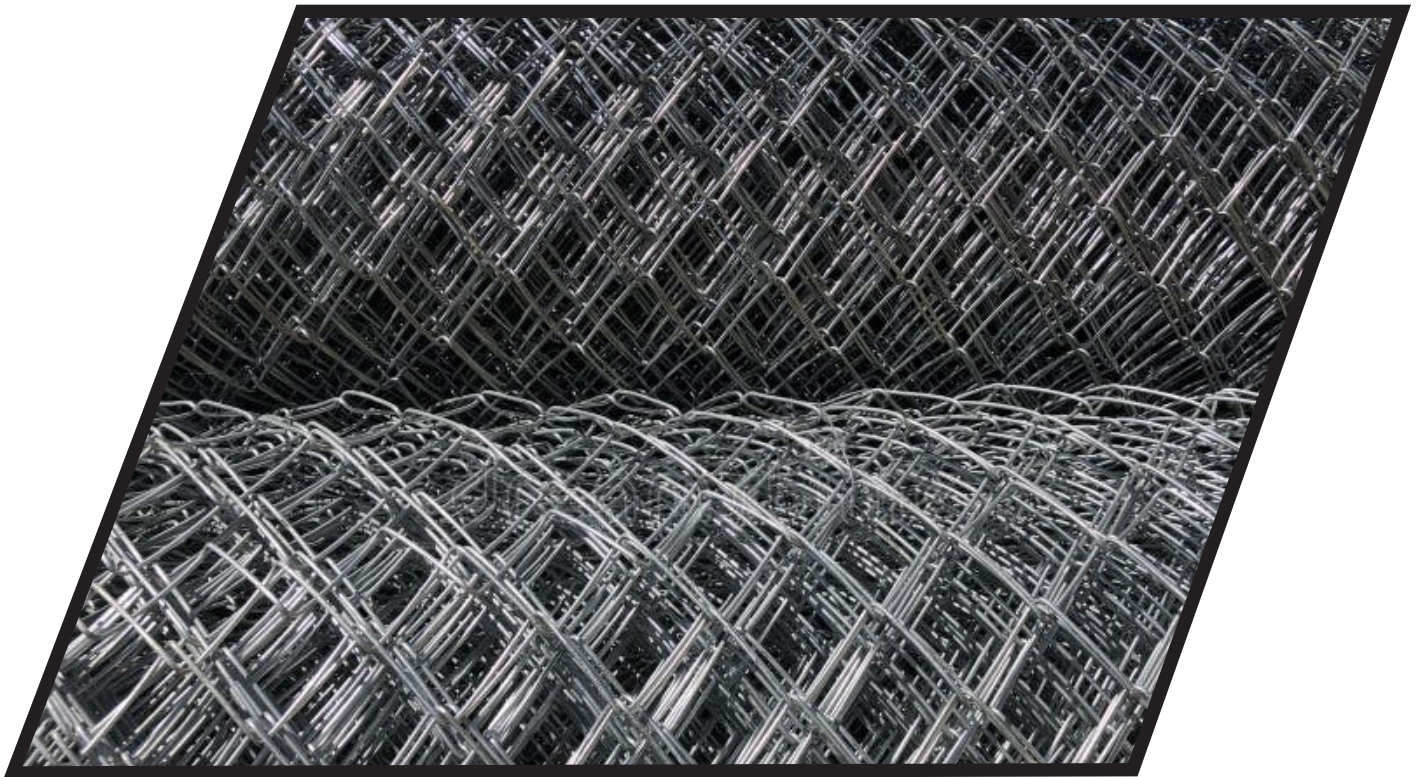

## 11 Gauge Galvanized (.115)

US Item #	◇	Edge	Height	Weight/ft	Unit (ft)	#/P
CLGB20011036ZZ	2"	KK	36"	1.14 lbs	Roll (50)	9
CLGB20011042ZZ	2"	KK	42"	1.33 lbs	Roll (50)	9
CLGB20011048ZZ	2"	KK	48"	1.80 lbs	Roll (50)	9
CLGB20011060ZZ	2"	KK	60"	2.00 lbs	Roll (50)	9
CLGB20011072ZZ	2"	BK, KK, BB	72"	2.85 lbs	Roll (50)	9
CLGB20011084ZZ	2"	BK, KK, BB	84"	3.30 lbs	Roll (50)	9
CLGB20011096ZZ	2"	BK, KK, BB	96"	3.80 lbs	Roll (50)	9
CLGB20011120ZZ	2"	BK, KK, BB	120"	4.05 lbs	Roll (50)	9
CLGB20011144ZZ	2"	BK, KK, BB	144"	5.65 lbs	Roll (50)	9



## 9 Gauge Galvanized (.145)

US Item #	◇	Edge	Height	Weight/ft	Unit (ft)	#/P
CLGB20009036ZZ	2"	KK	36"	2.18 lbs	Roll (50)	9
CLGB20009042ZZ	2"	KK	42"	2.55 lbs	Roll (50)	9
CLGB20009048ZZ	2"	KK	48"	2.91 lbs	Roll (50)	9
CLGB20009060ZZ	2"	KK	60"	3.64 lbs	Roll (50)	9
CLGB20009072ZZ	2"	BK, KK, BB	72"	4.37 lbs	Roll (50)	9
CLGB20009084ZZ	2"	BK, KK, BB	84"	5.10 lbs	Roll (50)	9
CLGB20009096ZZ	2"	BK, KK, BB	96"	5.82 lbs	Roll (50)	9
CLGB20009108ZZ	2"	BK, KK, BB	108"	6.55 lbs	Roll (50)	9
CLGB20009120ZZ	2"	BK, KK, BB	120"	7.28 lbs	Roll (50)	9
CLGB20009144ZZ	2"	BK, KK, BB	144"	8.74 lbs	Roll (50)	9
CLGB13409036ZZ	1 3/4"	KK	36"	2.73 lbs	Roll (25)	16
CLGB13409042ZZ	1 3/4"	KK	42"	3.19 lbs	Roll (25)	16
CLGB13409048ZZ	1 3/4"	KK	48"	3.65 lbs	Roll (25)	16
CLGB13409060ZZ	1 3/4"	KK	60"	4.56 lbs	Roll (25)	16
CLGB13409072ZZ	1 3/4"	BK, KK, BB	72"	5.47 lbs	Roll (25)	16
CLGB13409084ZZ	1 3/4"	BK, KK, BB	84"	6.38 lbs	Roll (25)	16
CLGB13409096ZZ	1 3/4"	BK, KK, BB	96"	7.28 lbs	Roll (25)	16
CLGB13409108ZZ	1 3/4"	BK, KK, BB	108"	8.20 lbs	Roll (25)	16
CLGB13409120ZZ	1 3/4"	BK, KK, BB	120"	9.11 lbs	Roll (25)	16
CLGB13409144ZZ	1 3/4"	BK, KK, BB	144"	10.93 lbs	Roll (25)	16
CLGB11209036ZZ	1 1/2"	KK	36"	2.61 lbs	Roll (25)	16
CLGB11209042ZZ	1 1/2"	KK	42"	3.12 lbs	Roll (25)	16
CLGB11209048ZZ	1 1/2"	KK	48"	3.56 lbs	Roll (25)	16
CLGB11209060ZZ	1 1/2"	KK	60"	4.46 lbs	Roll (25)	16

## 9 Gauge Galvanized (.145)

US Item #	◇	Edge	Height	Weight/ft	Unit (ft)	#/P
CLGB11209072ZZ	1 1/2"	BK, KK, BB	72"	5.34 lbs	Roll (25)	16
CLGB11209084ZZ	1 1/2"	BK, KK, BB	84"	6.24 lbs	Roll (25)	16
C.T.O.	1 1/2"	BK, KK, BB	96"	7.12 lbs	Roll (25)	16
CLGB11209108ZZ	1 1/2"	BK, KK, BB	108"	8.02 lbs	Roll (25)	16
CLGB11209120ZZ	1 1/2"	BK, KK, BB	120"	9.10 lbs	Roll (25)	16
CLGB11209144ZZ	1 1/2"	BK, KK, BB	144"	10.68 lbs	Roll (25)	16
CLGB11409036ZZ	1 1/4"	KK	36"	4.00 lbs	Roll (25)	16
CLGB11409042ZZ	1 1/4"	KK	42"	4.66 lbs	Roll (25)	16
CLGB11409048ZZ	1 1/4"	KK	48"	5.33 lbs	Roll (25)	16
CLGB11409060ZZ	1 1/4"	KK	60"	6.67 lbs	Roll (25)	16
CLGB11409072ZZ	1 1/4"	BK, KK, BB	72"	8.00 lbs	Roll (25)	16
CLGB11409084ZZ	1 1/4"	BK, KK, BB	84"	9.33 lbs	Roll (25)	16
C.T.O.	1 1/4"	BK, KK, BB	96"	10.66 lbs	Roll (25)	16
CLGB11409108ZZ	1 1/4"	BK, KK, BB	108"	12.00 lbs	Roll (25)	16
CLGB11409120ZZ	1 1/4"	BK, KK, BB	120"	13.30 lbs	Roll (25)	16
CLGB11409144ZZ	1 1/4"	BK, KK, BB	144"	16.00 lbs	Roll (25)	16
CLGB10009036ZZ	1"	KK	36"	4.65 lbs	Roll (25)	16
CLGB10009042ZZ	1"	KK	42"	5.43 lbs	Roll (25)	16
CLGB10009048ZZ	1"	KK	48"	6.30 lbs	Roll (25)	16
CLGB10009060ZZ	1"	KK	60"	7.75 lbs	Roll (25)	16
CLGB10009072ZZ	1"	BK, KK, BB	72"	9.30 lbs	Roll (25)	16
CLGB10009084ZZ	1"	BK, KK, BB	84"	10.85 lbs	Roll (25)	16
CLGB10009296ZZ	1"	BK, KK, BB	96"	12.40 lbs	Roll (25)	16
CLGB10009108ZZ	1"	BK, KK, BB	108"	13.95 lbs	Roll (25)	16
CLGB10009120ZZ	1"	BK, KK, BB	120"	15.50 lbs	Roll (25)	16
CLGB10009144ZZ	1"	BK, KK, BB	144"	18.60 lbs	Roll (25)	16

## 6 Gauge Galvanized (.192)

US Item #	◇	Edge	Height	Weight/ft	Unit (ft)	#/P
00600ZZ	2"	KK	36"	3.64 lbs	Roll (25)	16
00601ZZ	2"	KK	42"	4.24 lbs	Roll (25)	16
00602ZZ	2"	KK,BB	48"	4.84 lbs	Roll (25)	16
00603ZZ	2"	KK	60"	6.06 lbs	Roll (25)	16
00604ZZ	2"	BK,KK,BB	72"	7.26 lbs	Roll (25)	16
00605ZZ	2"	BK,KK,BB	84"	8.48 lbs	Roll (25)	16
00606ZZ	2"	BK,KK,BB	96"	8.73 lbs	Roll (25)	16
00607ZZ	2"	BK,KK,BB	108"	10.90 lbs	Roll (25)	16
00608ZZ	2"	BK,KK,BB	120"	12.10 lbs	Roll (25)	16
00610ZZ	2"	BK,KK,BB	144"	14.52 lbs	Roll (25)	16
00630ZZ	1.75"	KK	36"	4.38 lbs	Roll (25)	16
00631ZZ	1.75"	KK	42"	5.12 lbs	Roll (25)	16
00632ZZ	1.75"	KK	48"	5.84 lbs	Roll (25)	16
00633ZZ	1.75"	KK	60"	7.30 lbs	Roll (25)	16
C.T.O.	1.75"	BK,KK,BB	72"	8.76 lbs	Roll (25)	16
00635ZZ	1.75"	BK,KK,BB	84"	10.20 lbs	Roll (25)	16
00636ZZ	1.75"	BK,KK,BB	96"	11.68 lbs	Roll (25)	16
00637ZZ	1.75"	BK,KK,BB	108"	13.14 lbs	Roll (25)	16
00638ZZ	1.75"	BK,KK,BB	120"	14.60 lbs	Roll (25)	16
00640ZZ	1.75"	BK,KK,BB	144"	17.52 lbs	Roll (25)	16
00660ZZ	1.5"	KK	36"	5.70 lbs	Roll (25)	16
00661ZZ	1.5"	KK	42"	6.65 lbs	Roll (25)	16
00662ZZ	1.5"	KK	48"	7.60 lbs	Roll (25)	16
00663ZZ	1.5"	KK	60"	9.50 lbs	Roll (25)	16
00664ZZ	1.5"	BK,KK,BB	72"	11.40 lbs	Roll (25)	16
00665ZZ	1.5"	BK,KK,BB	84"	13.30 lbs	Roll (25)	16
00666ZZ	1.5"	BK,KK,BB	96"	15.20 lbs	Roll (25)	16
00667ZZ	1.5"	BK,KK,BB	108"	17.10 lbs	Roll (25)	16
00668ZZ	1.5"	BK,KK,BB	120"	22.80 lbs	Roll (25)	16
00670ZZ	1.5"	BK,KK,BB	144"	26.35 lbs	Roll (25)	16

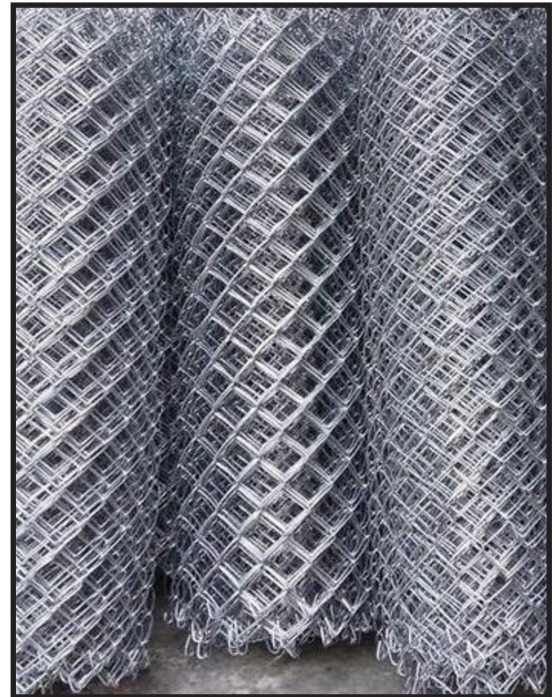

## 9 Gauge Vinyl Extruded

US Item #	Colour	◇	Edge	Height	Weight/ft	Unit (ft)	#/P
CL(YY)20009036KK	BL,GN	2"	KK	36"	1.23 lbs	Roll (50)	9
CL(YY)20009042KK	BL,GN	2"	KK	42"	1.44 lbs	Roll (50)	9
CL(YY)20009048KK	BL,GN	2"	KK	48"	1.64 lbs	Roll (50)	9
CL(YY)20009060KK	BL,GN	2"	KK	60"	2.05 lbs	Roll (50)	9
CL(YY)20009072KK	BL,GN	2"	KK	72"	2.46 lbs	Roll (50)	9

## 8 Gauge Vinyl Extruded

US Item #	Colour	◇	Edge	Height	Weight/ft	Unit (ft)	#/P
CL(YY)20008036KK	BL,GN	2"	KK	36"	1.40 lbs	Roll (50)	9
CL(YY)20008042KK	BL,GN	2"	KK	42"	1.62 lbs	Roll (50)	9
CL(YY)20008048KK	BL,GN	2"	KK	48"	2.16 lbs	Roll (50)	9
CL(YY)20008060KK	BL,GN	2"	KK	60"	2.70 lbs	Roll (50)	9
CL(YY)20008072KK	BL,GN	2"	KK	72"	3.24 lbs	Roll (50)	9
CL(YY)20008084KK	BL,GN	2"	KK	80"	3.78 lbs	Roll (50)	9
CL(YY)20008096KK	BL,GN	2"	KK	96"	4.32 lbs	Roll (50)	9

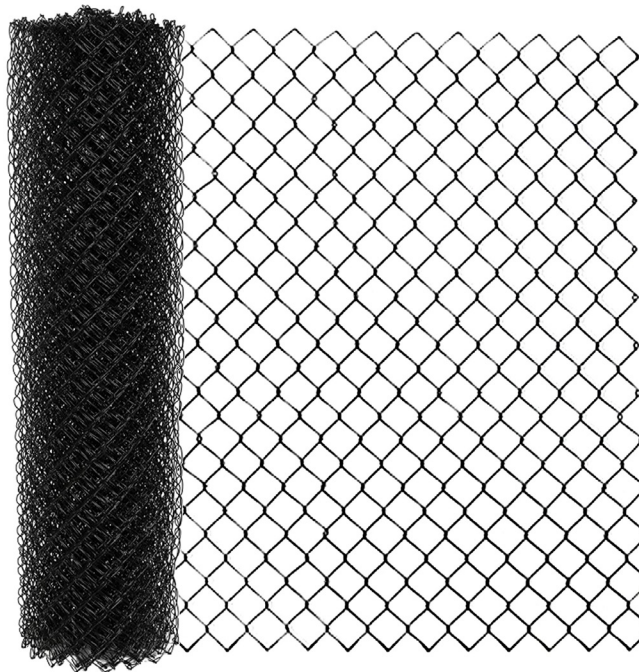

## 6 Gauge Vinyl - Black (BL)

US Item #	◇	Edge	Height	Weight/ft
CLBK20006036ZZ	2"	BK, KK, BB	36"	2.40 lbs
CLBK20006042ZZ	2"	BK, KK, BB	42"	2.72 lbs
C.T.O.	2"	BK, KK, BB	48"	3.10 lbs
C.T.O.	2"	BK, KK, BB	60"	3.88 lbs
CL(XX)20006072ZZ	2"	BK, KK, BB	72"	4.66 lbs
C.T.O.	2"	BK, KK, BB	84"	5.42 lbs
CL(XX)20006096ZZ	2"	BK, KK, BB	96"	6.20 lbs
C.T.O.	2"	BK, KK, BB	108"	6.98 lbs
C.T.O.	2"	BK, KK, BB	120"	7.76 lbs
C.T.O.	2"	BK, KK, BB	144"	9.30 lbs
C.T.O.	1.75"	BK, KK, BB	36"	2.40 lbs
C.T.O.	1.75"	BK, KK, BB	42"	2.90 lbs
C.T.O.	1.75"	BK, KK, BB	48"	3.34 lbs
C.T.O.	1.75"	BK, KK, BB	60"	4.16 lbs
C.T.O.	1.75"	BK, KK, BB	72"	5.00 lbs
C.T.O.	1.75"	BK, KK, BB	84"	5.80 lbs
C.T.O.	1.75"	BK, KK, BB	96"	6.66 lbs
C.T.O.	1.75"	BK, KK, BB	108"	7.50 lbs
C.T.O.	1.75"	BK, KK, BB	120"	8.34 lbs
C.T.O.	1.75"	BK, KK, BB	144"	10.00 lbs



US Item #	◇	Edge	Height	Weight/ft
C.T.O.	1.5"	BK, KK, BB	36"	N/A
C.T.O.	1.5"	BK, KK, BB	42"	N/A
C.T.O.	1.5"	BK, KK, BB	48"	N/A
C.T.O.	1.5"	BK, KK, BB	60"	N/A
C.T.O.	1.5"	BK, KK, BB	72"	N/A
C.T.O.	1.5"	BK, KK, BB	84"	N/A
C.T.O.	1.5"	BK, KK, BB	96"	N/A
C.T.O.	1.5"	BK, KK, BB	108"	N/A
C.T.O.	1.5"	BK, KK, BB	120"	N/A
C.T.O.	1.5"	BK, KK, BB	144"	N/A
C.T.O.	1.25"	BK, KK, BB	36"	3.00 lbs
C.T.O.	1.25"	BK, KK, BB	42"	4.30 lbs
C.T.O.	1.25"	BK, KK, BB	48"	4.88 lbs
C.T.O.	1.25"	BK, KK, BB	60"	6.10 lbs
C.T.O.	1.25"	BK, KK, BB	72"	7.32 lbs
C.T.O.	1.25"	BK, KK, BB	84"	8.50 lbs
C.T.O.	1.25"	BK, KK, BB	96"	9.70 lbs
C.T.O.	1.25"	BK, KK, BB	108"	10.98 lbs
C.T.O.	1.25"	BK, KK, BB	120"	11.00 lbs
C.T.O.	1.25"	BK, KK, BB	144"	13.00 lbs
C.T.O.	1"	BK, KK, BB	36"	4.70 lbs
C.T.O.	1"	BK, KK, BB	42"	4.80 lbs
C.T.O.	1"	BK, KK, BB	48"	5.56 lbs
C.T.O.	1"	BK, KK, BB	60"	6.95 lbs
C.T.O.	1"	BK, KK, BB	72"	8.34 lbs
C.T.O.	1"	BK, KK, BB	84"	9.73 lbs
C.T.O.	1"	BK, KK, BB	96"	11.12 lbs
C.T.O.	1"	BK, KK, BB	108"	12.51 lbs
C.T.O.	1"	BK, KK, BB	120"	13.90 lbs
C.T.O.	1"	BK, KK, BB	144"	16.68 lbs

Note: All SKUs come in rolls of 25ft with 16 rolls per pallet

# **PROLINK** **SUPPLY**

## Privacy Slats



## Colour Legend (See p.6 for more information)

From left to right are the colours available for slats ('XX'):

Royal Blue (RB), Brown (BR), RedWood (RW), White (WH), Sky Blue (SB), Black (BL), Grey (GY), Tan (TN), and Green (GR)



This mesh comes preslatted for easy installation and extra coverage.

## Mesh colours/materials are as follows ('YY'):

Galvanized (G)  
Black (BK)  
Green (GN)  
Brown (BN)

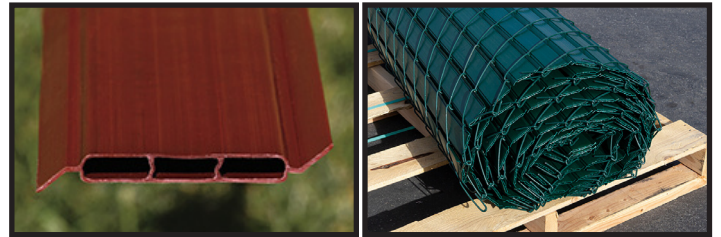

## PlasticLink Pre-Slatted Fabric

CAD Item #	US Item #	Description	Height	Weight/ft	Unit (ft)
C.T.O.	PL048(YY)(XX)	PlasticLink Pre-Slatted Fabric - 3.77 lbs/ft	48"	3.77 lbs	Roll (25)
C.T.O.	PL060(YY)(XX)	PlasticLink Pre-Slatted Fabric - 4.71 lbs/ft	60"	4.71 lbs	Roll (25)
C.T.O.	PL072(YY)(XX)	PlasticLink Pre-Slatted Fabric - 5.65 lbs/ft	72"	5.65 lbs	Roll (25)
C.T.O.	PL084(YY)(XX)	PlasticLink Pre-Slatted Fabric - 6.59 lbs/ft	84"	6.59 lbs	Roll (25)
C.T.O.	PL096(YY)(XX)	PlasticLink Pre-Slatted Fabric - 7.54 lbs/ft	96"	7.54 lbs	Roll (25)
C.T.O.	PL120(YY)(XX)	PlasticLink Pre-Slatted Fabric - 9.42 lbs/ft	120"	9.42 lbs	Roll (25)
C.T.O.	PL144(YY)(XX)	PlasticLink Pre-Slatted Fabric - 11.30 lbs/ft	144"	11.390 lbs	Roll (25)

## PlasticLink Plus Pre-Slatted Fabric

CAD Item #	US Item #	Description	Height	Weight/ft	Unit (ft)
C.T.O.	PP048(YY)(XX)	48" PlasticLink Plus Pre-Slatted Fabric - 4.00 lbs/ft	48"	4.00 lbs	Roll (25)
C.T.O.	PP060(YY)(XX)	60" PlasticLink Plus Pre-Slatted Fabric - 5.00 lbs/ft	60"	5.00 lbs	Roll (25)
C.T.O.	PP072(YY)(XX)	72" PlasticLink Plus Pre-Slatted Fabric - 6.00 lbs/ft	72"	6.00 lbs	Roll (25)
C.T.O.	PP084(YY)(XX)	84" PlasticLink Plus Pre-Slatted Fabric - 7.00 lbs/ft	84"	7.00 lbs	Roll (25)
C.T.O.	PP096(YY)(XX)	96" PlasticLink Plus Pre-Slatted Fabric - 8.00 lbs/ft	96"	8.00 lbs	Roll (25)
C.T.O.	PP120(YY)(XX)	120" PlasticLink Plus Pre-Slatted Fabric - 10.00 lbs/ft	120"	10.00 lbs	Roll (25)
C.T.O.	PP144(YY)(XX)	144" PlasticLink Plus Pre-Slatted Fabric - 12.00 lbs/ft	144"	12.00 lbs	Roll (25)

## LiteLink Slats

CAD Item #	US Item #	Description	Height	Weight/ft	Length/batch
07520-XX	SL300LL (XX)	36" LiteLink Slats - 4.00 lbs/ft	36"	4.00 lbs	10'
07521-XX	SL312LL (XX)	42" LiteLink Slats - 4.00 lbs/ft	42"	4.00 lbs	10'
07522-XX	SL400LL (XX)	48" LiteLink Slats - 5.00 lbs/ft	48"	5.00 lbs	10'
07523-XX	SL500LL (XX)	60" LiteLink Slats - 7.00 lbs/ft	60"	7.00 lbs	10'
07524-XX	SL600LL (XX)	72" LiteLink Slats - 8.00 lbs/ft	72"	8.00 lbs	10'
07525-XX	SL700LL (XX)	84" LiteLink Slats - 10.00 lbs/ft	84"	10.00 lbs	10'
07526-XX	SL800LL (XX)	96" LiteLink Slats - 11.00 lbs/ft	96"	11.00 lbs	10'

## Winged Slats: Fits 9 Ga. Chainlink

CAD Item #	US Item #	Description	Height	Weight/ft	Length/batch
07560-XX	C.T.O.	36" Winged Slats - 5.00 lbs/ft	36"	5.00 lbs	10'
07561-XX	C.T.O.	42" Winged Slats - 6.00 lbs/ft	42"	6.00 lbs	10'
07562-XX	SL400WS (XX)	42" Winged Slats - 8.00 lbs/ft	48"	8.00 lbs	10'
07563-XX	SL500WS (XX)	60" Winged Slats - 10.00 lbs/ft	60"	10.00 lbs	10'
07564-XX	SL600WS (XX)	72" Winged Slats - 12.00 lbs/ft	72"	12.00 lbs	10'
07565-XX	SL700WS (XX)	84" Winged Slats - 15.00 lbs/ft	84"	15.00 lbs	10'
07566-XX	SL800WS (XX)	96" Winged Slats - 21.00 lbs/ft	96"	21.00 lbs	10'

## FinLink Slats: Fits 11 Ga. Chainlink

CAD Item #	US Item #	Description	Height	Weight/ft	Length/batch
07540-XX	C.T.O.	36" FinLink Slats - 5.00 lbs/ft	36"	5.00 lbs	10'
07541-XX	C.T.O.	42" FinLink Slats - 6.00 lbs/ft	42"	6.00 lbs	10'
07542-XX	SL400FL (XX)	48" FinLink Slats - 8.00 lbs/ft	48"	8.00 lbs	10'
07543-XX	SL500FL (XX)	60" FinLink Slats - 10.00 lbs/ft	60"	10.00 lbs	10'
07544-XX	SL600FL (XX)	72" FinLink Slats - 12.00 lbs/ft	72"	12.00 lbs	10'
07545-XX	SL700FL (XX)	84" FinLink Slats - 15.00 lbs/ft	84"	15.00 lbs	10'
07546-XX	SL800FL (XX)	96" FinLink Slats - 21.00 lbs/ft	96"	21.00 lbs	10'

## American Flag Slat Kit

CAD Item #	US Item #	Description	Height	Weight/ft	Unit (ft)
"	PL048(YY)(XX)	4' x 6' American Flag Kit	48"	3.77 lbs	Roll (25)



## Bottom Lock Slats: Fits 9 Ga. Chainlink

CAD Item #	US Item #	Description	Height	Weight/ft	Unit (ft)
07500-XX	SL300BL (XX)	36" Bottom Lock Slats for 9 Ga. mesh - 5.00 lbs/ft	36"	5.00 lbs	Roll (25)
07501-XX	SL312BL (XX)	42" Bottom Lock Slats for 9 Ga. mesh - 5.00 lbs/ft	42"	5.00 lbs	Roll (25)
07502-XX	SL400BL (XX)	48" Bottom Lock Slats for 9 Ga. mesh - 8.00 lbs/ft	48"	8.00 lbs	Roll (25)
07503-XX	SL500BL (XX)	60" Bottom Lock Slats for 9 Ga. mesh - 10.00 lbs/ft	60"	10.00 lbs	Roll (25)
07504-XX	SL600BL (XX)	72" Bottom Lock Slats for 9 Ga. mesh - 12.00 lbs/ft	72"	12.00 lbs	Roll (25)
07505-XX	SL700BL (XX)	84" Bottom Lock Slats for 9 Ga. mesh - 15.00 lbs/ft	84"	15.00 lbs	Roll (25)
07506-XX	SL800BL (XX)	96" Bottom Lock Slats for 9 Ga. mesh - 21.00 lbs/ft	96"	21.00 lbs	Roll (25)
07507-XX	SL100BL (XX)	120" Bottom Lock Slats for 9 Ga. mesh - 26.00 lbs/ft	120"	26.00 lbs	Roll (25)
07508-XX	SL120BL (XX)	144" Bottom Lock Slats for 9 Ga. mesh - 28.00 lbs/ft	144"	28.00 lbs	Roll (25)

## Hedge Link

CAD Item #	US Item #	Description	Height	Weight/ft
7600	SL400HLGN	48" HedgeLink - 8.00 lbs/ft	48"	8.00 lbs
7601	SL500HLGN	60" HedgeLink - 10.00 lbs/ft	60"	10.00 lbs
7602	SL600HLGN	72" HedgeLink - 12.00 lbs/ft	72"	12.00 lbs
7603	SL700HLGN	84" HedgeLink - 15.00 lbs/ft	84"	15.00 lbs
7604	SL800HLGN	96" HedgeLink - 21.00 lbs/ft	96"	21.00 lbs



## Reflective Fence Insert

CAD Item #	US Item #	Description	Height	Weight/bag
C.T.O.	SL400REFG	4' Reflective Insert - Gold	48"	2.75 lbs
C.T.O.	SL400REFR	4' Reflective Insert - Red	48"	2.75 lbs
C.T.O.	SL400REFS	4' Reflective Insert - Silver	48"	2.75 lbs

# PROLINK SUPPLY

## Pipe (Canada)



## Full Length Pipe - Galvanized, Commercial Weight

CAD Item #	Size	Length	Weight	#/Bundle
2065	1 3/8"	10' 6" S.E.	11.00 lbs	91
2020	1 3/8"	21' S.E.	22.00 lbs	91
2022	1 3/8"	21'	22.00 lbs	91
2024	1 3/8"	24'	25.00 lbs	91
2105	1 5/8"	10' 6" S.E.	13.80 lbs	61
2026	1 5/8"	21' S.E.	27.70 lbs	61
2028	1 5/8"	21'	27.70 lbs	61
2030	1 5/8"	24'	31.70 lbs	61
2032	1 7/8"	21'	32.10 lbs	61
2034	1 7/8"	24'	36.70 lbs	61
2036	2 3/8"	21'	40.10 lbs	37
2038	2 3/8"	24'	46.80 lbs	37
2040	2 7/8"	21'	72.00 lbs	19
2042	2 7/8"	24'	82.10 lbs	19
2044	3 1/2"	21'	88.40 lbs	14
2046	3 1/2"	24'	101.00 lbs	14

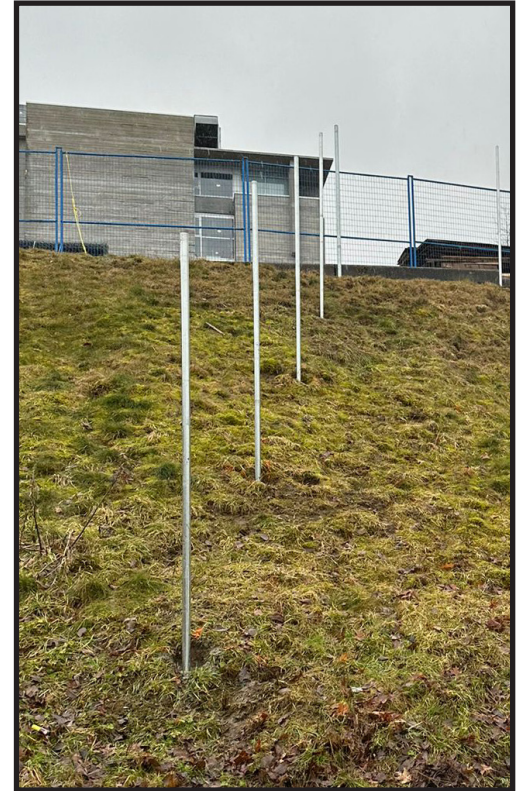

## Cut Pipe - Galvanized, Commercial Weight

CAD Item #	Size	Length	Weight	#/Bundle
C.T.O.	1 5/8"	5'6"	7.25 lbs	61
02154	1 7/8"	6'	9.20 lbs	61
02156	1 7/8"	7'	10.70 lbs	61
02158	1 7/8"	8'	12.20 lbs	61
02160	1 7/8"	9'	13.80 lbs	61
02163	1 7/8"	10' 6"	16.10 lbs	61
02166	1 7/8"	12'	18.40 lbs	61
02194	2 3/8"	6'	11.70 lbs	37
02196	2 3/8"	7'	13.70 lbs	37
02198	2 3/8"	8'	15.60 lbs	37
02200	2 3/8"	9'	17.00 lbs	37
02203	2 3/8"	10' 6"	20.50 lbs	37
02206	2 3/8"	12'	23.40 lbs	37
02234	2 7/8"	6'	20.50 lbs	19
02236	2 7/8"	7'	23.90 lbs	19
02238	2 7/8"	8'	27.30 lbs	19
02240	2 7/8"	9'	30.70 lbs	19
02243	2 7/8"	10' 6"	35.90 lbs	19
02246	2 7/8"	12'	41.10 lbs	19
02274	3 1/2"	6'	25.30 lbs	14
02276	3 1/2"	7'	29.50 lbs	14
02278	3 1/2"	8'	33.70 lbs	14
02280	3 1/2"	9'	37.89 lbs	14
02283	3 1/2"	10' 6"	44.20 lbs	14
02286	3 1/2"	12'	50.50 lbs	14



## Full Length & Cut Pipe - Galvanized Sch 40

### Full Length

CAD Item #	Size	Length	Weight	#/Bundle
02520	1 3/8"	21'	35.30 lbs	61
02528	1 5/8"	21'	47.67 lbs	42
02530	1 5/8"	24'	54.48 lbs	42
C.T.O.	1 7/8"	18'	47.67 lbs	36
02532	1 7/8"	21'	57.12 lbs	36
02534	1 7/8"	24'	65.28 lbs	36
C.T.O.	2 3/8"	18'	48.96 lbs	37
02536	2 3/8"	21'	76.65 lbs	26
02538	2 3/8"	24'	87.60 lbs	26
C.T.O.	2 7/8"	18'	83.52 lbs	18
02540	2 7/8"	21'	97.44 lbs	18
02542	2 7/8"	24'	111.36 lbs	18
02544	3 1/2"	21'	119.91 lbs	14
02546	3 1/2"	24'	137.04 lbs	14
02548	4 1/2"	21'	226.50 lbs	10
02550	4 1/2"	24'	259.00 lbs	10
02552	6 5/8"	21'	399.00 lbs	4
02554	6 5/8"	24'	455.20 lbs	4
02556	8 5/8"	21'	600.00 lbs	
02558	8 5/8"	24'	685.20 lbs	

### Cut

CAD Item #	Size	Length	Weight	#/Bundle
C.T.O.	1 7/8"	8'	18.2 lbs	61
C.T.O.	1 7/8"	9'	20.5 lbs	61
C.T.O.	1 7/8"	10'6"	23.9 lbs	61
02684	2 3/8"	6'	21.9 lbs	26
02686	2 3/8"	7'	25.5 lbs	26
02688	2 3/8"	8'	25 lbs	26
C.T.O.	2 3/8"	8'8"	26.8 lbs	37
02690	2 3/8"	9'	28.1 lbs	26
02693	2 3/8"	10'6"	32.8 lbs	26
02696	2 3/8"	12'	37.4 lbs	26
02724	2 7/8"	6'	34.74 lbs	18
02726	2 7/8"	7'	40.53 lbs	18
02728	2 7/8"	8'	46.32 lbs	18
02730	2 7/8"	9'	52.1 lbs	18
02733	2 7/8"	10'6"	60.8 lbs	18
02736	2 7/8"	12'	69.48 lbs	18
02764	3 1/2"	6'	45.4 lbs	14
02766	3 1/2"	7'	53.1 lbs	14
02768	3 1/2"	8'	60.6 lbs	14
02770	3 1/2"	9'	68.2 lbs	14
02773	3 1/2"	10'6"	79.6 lbs	14
02776	3 1/2"	12'	91.4 lbs	14

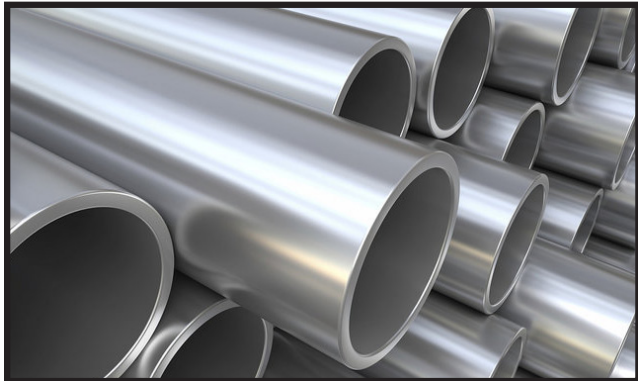

## Full Length Pipe - Black Powdercoated, Commercial Weight

CAD Item #	Size	Length	Weight	#/Bundle
03502	1 3/8"	21' S.E.	21.76 lbs	36
03531	1 3/8"	10' 6" S.E.	24.48 lbs	36
03505	1 5/8"	21' S.E.	28.56 lbs	36
03547	1 5/8"	10' 6" S.E.	29.20 lbs	26
03542	1 5/8"	6'	32.85 lbs	26
03544	1 5/8"	7'	38.33 lbs	26
03562	1 7/8"	6'	43.80 lbs	26
03564	1 7/8"	7'	46.32 lbs	19
03566	1 7/8"	8'	52.11 lbs	19
03582	2 3/8"	6'	60.80 lbs	19
03584	2 3/8"	7'	69.48 lbs	19
03586	2 3/8"	8'	72.88 lbs	12
03588	2 3/8"	9'	81.99 lbs	12
03590	2 3/8"	10'	95.66 lbs	12
03594	2 3/8"	12'	109.32 lbs	12
03612	2 7/8"	7'	151.76 lbs	7
03614	2 7/8"	8'	170.73 lbs	7
03616	2 7/8"	9'	199.19 lbs	7
03618	2 7/8"	10'	227.64 lbs	7
03624	2 7/8"	13'	299.78 lbs	3



## Cut Pipe - Black Powdercoated

CAD Item #	Size	Length	Weight	#/Bundle
C.T.O.	1 5/8"	5' 6"	6.11 lbs	61
C.T.O.	1 7/8"	6'	7.62 lbs	61
C.T.O.	1 7/8"	7'	8.89 lbs	61
C.T.O.	1 7/8"	8'	10.16 lbs	61
C.T.O.	2 3/8"	6'	9.60 lbs	37
C.T.O.	2 3/8"	7'	11.20 lbs	37
C.T.O.	2 3/8"	8'	12.80 lbs	37



## Pipe - Black Powdercoated (Sch 40)

CAD Item #	Size	Length	Weight	#/Bundle
03704	1 5/8"	21'	47.7 lbs	42
03786	2 3/8"	8'	15.6 lbs	26
03790	2 3/8"	10'	17.6 lbs	26
03794	2 3/8"	12'	43.8 lbs	26
03819	2 7/8"	10' 6"	60.8 lbs	18
03821	2 7/8"	12' 6"	72.4 lbs	18
03839	3 1/2"	10' 6"	23.9 lbs	14
03842	3 1/2"	12'	27.3 lbs	14
C.T.O.	1 7/8"	96"	18.24 lbs	61
C.T.O.	2 3/8"	96"	24.96 lbs	37



## Galvanized Square Tubing

CAD Item #	Size	Length	Weight	#/Bundle
08050	3/4" x 3/4"	24'	15.30 lbs	144
08060	1" x 1"	24'	19.50 lbs	121
C.T.O.	1 1/4" x 1 1/4"	24'	23.10 lbs	144
C.T.O.	1 1/2" x 1 1/2"	24'	34.60 lbs	81
08070	1 1/2" x 1 1/2"	24'	32.00 lbs	81
C.T.O.	1" x 2"	24'	38.10 lbs	96
08120	1" x 2"	24'	29.90 lbs	72
C.T.O.	2" x 2"	24'	73.20 lbs	25
08080	2" x 2"	24'	60.00 lbs	36
C.T.O.	2" x 2"	24'	37.50 lbs	25
08090	3" x 3"	24'	92.00 lbs	25
08100	4" x 4"	24'	123.00 lbs	16
C.T.O.	2" x 3"	24'	58.60 lbs	25
08140	2" x 4"	24'	92.00 lbs	36
C.T.O.	2" x 4"	24'	69.90 lbs	20
C.T.O.	2 1/2" x 2 1/2"	24'	92.40 lbs	25
C.T.O.	3" x 3"	24'	111.60 lbs	25
C.T.O.	4" x 4"	24'	150.10 lbs	16



# **PRO/INK** **SUPPLY**

## Pipe (U.S.A.)



## Full Length Pipe - Galvanized

US Item #	Size	Gauge	Length	Weight	#/Bundle
17TU138126S	1 3/8"	17	10' 6" S.E.	11.00 lbs	91
16TU138252S	1 3/8"	16	21' S.E.	22.00 lbs	91
16TU138252P	1 3/8"	16	21'	22.00 lbs	91
16TU138288P	1 3/8"	16	24'	25.00 lbs	91
16TU158126S	1 5/8"	16	10' 6" S.E.	13.80 lbs	61
16TU158252S	1 5/8"	16	21' S.E.	27.70 lbs	61
16TU158252P	1 5/8"	16	21'	27.70 lbs	61
16TU158288P	1 5/8"	16	24'	31.70 lbs	61
15TU158288P	1 5/8"	15	24'		61
16TU178252P	1 7/8"	16	21'	32.10 lbs	61
16TU178288P	1 7/8"	16	24'	36.70 lbs	61
16TU238252P	2 3/8"	16	21'	40.10 lbs	37
16TU238288P	2 3/8"	16	24'	46.80 lbs	37
C.T.O.	2 7/8"		21'	72.00 lbs	19
C.T.O.	2 7/8"		24'	82.10 lbs	19



## Cut Pipe - Galvanized

US Item #	Size	Gauge	Length	Weight	#/Bundle
16TU158066P	1 5/8"	16	5'6"		61
16TU178072P	1 7/8"	16	6'	9.20 lbs	61
16TU178084P	1 7/8"	16	7'	10.70 lbs	61
16TU178096P	1 7/8"	16	8'	12.20 lbs	61
C.T.O.	1 7/8"		9'	13.80 lbs	61
C.T.O.	1 7/8"		10' 6"	16.10 lbs	61
C.T.O.	1 7/8"		12'	18.40 lbs	61
16TU238072P	2 3/8"	16	6'	11.70 lbs	37
16TU238084P	2 3/8"	16	7'	13.70 lbs	37
16TU238090P	2 3/8"	16	8'	15.60 lbs	37
16TU238096P	2 3/8"	16	9"	17.00 lbs	37
16TU238108P	2 3/8"	16	10' 6"	20.50 lbs	37
C.T.O.	2 3/8"	16	12'	23.40 lbs	37
C.T.O.	2 7/8"		6'	20.50 lbs	19
C.T.O.	2 7/8"		7'	23.90 lbs	19
C.T.O.	2 7/8"		8'	27.30 lbs	19
C.T.O.	2 7/8"		9'	30.70 lbs	19
C.T.O.	2 7/8"		10' 6"	35.90 lbs	19
C.T.O.	2 7/8"		12'	41.10 lbs	19



## Full Length & Cut Pipe - Galvanized Sch 20

### Full Length

US Item #	Size	Length	Weight	#/Bundle
20WT138252P	1 3/8"	21'	22.05 lbs	91
20WT158252S	1 5/8"	21'S.E.	30.03 lbs	61
20WT158252P	1 5/8"	21'	30.03 lbs	61
20WT158288P	1 5/8"	24'	34.32 lbs	61
20WT178216P	1 7/8"	18'	31.32 lbs	61
20WT178252P	1 7/8"	21'	36.54 lbs	61
20WT178288P	1 7/8"	24'	41.76 lbs	61
20WT238216P	2 3/8"	18'	41.76 lbs	37
20WT238252P	2 3/8"	21'	48.72 lbs	37
20WT238288P	2 3/8"	24'	55.68 lbs	37
20WT278216P	2 7/8"	18'	58.50 lbs	19
20WT278252P	2 7/8"	21'	68.25 lbs	19
20WT278288P	2 7/8"	24'	78.00 lbs	19

### Cut Pipe

US Item #	Size	Length	Weight	#/Bundle
20WT178072P	1 7/8"	6'	10.4 lbs	61
20WT178084P	1 7/8"	7'	12.2 lbs	61
20WT178096P	1 7/8"	8'	13.9 lbs	61
20WT238072P	1 5/8"	6'	13.9 lbs	37
20WT238084P	1 5/8"	7'	16.24 lbs	37
20WT238096P	1 5/8"	8'	18.56 lbs	37
20WT238108P	1 7/8"	9'	20.88 lbs	37
20WT278096P	2 3/8"	8'	26.0 lbs	19
20WT278108P	2 3/8"	9'	29.3 lbs	19

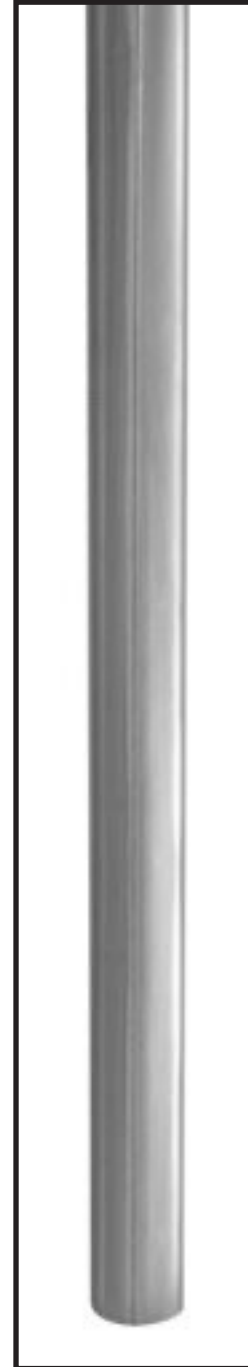

## Full Length & Cut Pipe - Galvanized Sch 40

### Full Length

US Item #	Size	Length	Weight	#/Bundle
40WT138252P	1 3/8"	21'	35.30 lbs	61
40WT158252S	1 5/8"	21' S.E.	47.67 lbs	61
40WT158252P	1 5/8"	21'	47.67 lbs	61
40WT158288P	1 5/8"	24'	44.16 lbs	61
40WT178216P	1 7/8"	18'	41.04 lbs	61
40WT178252P	1 7/8"	21'	47.88 lbs	61
40WT178288P	1 7/8"	24'	54.72 lbs	61
40WT238216P	2 3/8"	18'	56.16 lbs	37
40WT238252P	2 3/8"	21'	65.52 lbs	37
40WT238288P	2 3/8"	24'	74.88 lbs	37
40WT238456P	2 3/8"	38'	118.56 lbs	37
40WT278216P	2 7/8"	18'	83.52 lbs	19
40WT278252P	2 7/8"	21'	97.44 lbs	19
40WT278288P	2 7/8"	24'	111.36 lbs	19
40WT400216P	4"	18'	117.72 lbs	19
40WT400252P	4"	21'	137.34 lbs	19
40WT400288P	4"	24'	156.96 lbs	19
C.T.O.	6 5/8"	21'	399.00 lbs	4
C.T.O.	6 5/8"	24'	455.20 lbs	4
C.T.O.	8 5/8"	21'	600.00 lbs	
C.T.O.	8 5/8"	24'	685.20 lbs	

### Cut

US Item #	Size	Length	Weight	#/Bundle
40WT178096P	1 7/8"	8'	18.20 lbs	61
40WT178108P	1 7/8"	9'	20.50 lbs	61
40WT178126P	1 7/8"	10'6"	23.90 lbs	61
C.T.O.	2 3/8"	6'	21.90 lbs	26
C.T.O.	2 3/8"	7'	25.50 lbs	26
40WT238096P	2 3/8"	8'	25.00 lbs	37
40WT238104P	2 3/8"	8'8"	26.80 lbs	37
40WT238108P	2 3/8"	9'	28.10 lbs	37
40WT238126P	2 3/8"	10'6"	32.80 lbs	37
40WT238144P	2 3/8"	12'	37.40 lbs	37
C.T.O.	2 7/8"	6'	34.74 lbs	18
C.T.O.	2 7/8"	7'	40.53 lbs	18
40WT278096P	2 7/8"	8'	46.32 lbs	19
40WT278108P	2 7/8"	9'	52.10 lbs	19
40WT278126P	2 7/8"	10'6"	60.80 lbs	19
40WT278144P	2 7/8"	12'	69.48 lbs	19
40WT400096P	4"	8'	52.30 lbs	19
40WT400108P	4"	9'	58.90 lbs	19
40WT400126P	4"	10'6"	68.70 lbs	19
40WT400144P	4"	12'	78.50 lbs	19



## Full Length & Cut Pipe - Galvanized Sch 40 (Imported)

### Full Length

US Item #	Size	Length	Weight	#/Bundle
40FW158252P	1 5/8"	21'	2.27 lbs	42
40FW158288P	1 5/8"	24'	2.27 lbs	42
40FW178252P	1 7/8"	21'	2.72 lbs	36
40FW178288P	1 7/8"	24'	2.72 lbs	36
40FW238216P	2 3/8"	18'	3.65 lbs	26
40FW238252P	2 3/8"	21'	3.65 lbs	26
40FW238288P	2 3/8"	24'	3.65 lbs	26
40FW278216P	2 7/8"	18'	5.79 lbs	18
40FW278252P	2 7/8"	21'	5.79 lbs	18
40FW278288P	2 7/8"	24'	5.79 lbs	18
40FW400216P	4"	18'	9.11 lbs	12
40FW400252P	4"	21'	9.11 lbs	12
40FW400288P	4"	24'	9.11 lbs	12
40FW658216P	6 5/8"	18'	18.97 lbs	7
40FW658252P	6 5/8"	21'	18.97 lbs	7
40FW658288P	6 5/8"	24'	18.97 lbs	7
40FW858252P	8 5/8"	21'	28.55 lbs	3
40FW858288P	8 5/8"	24'	28.55 lbs	3

### Cut

US Item #	Size	Length	Weight	#/Bundle
40FW178096P	1 7/8"	8'	21.76 lbs	36
40FW178108P	1 7/8"	9'	24.48 lbs	36
40FW178126P	1 7/8"	10' 6"	28.56 lbs	36
40FW238096P	2 3/8"	8'	29.20 lbs	26
40FW238108P	2 3/8"	9'	32.85 lbs	26
40FW238126P	2 3/8"	10' 6"	38.33 lbs	26
40FW238144P	2 3/8"	12'	43.80 lbs	26
40FW278096P	2 7/8"	8'	46.32 lbs	19
40FW278108P	2 7/8"	9'	52.11 lbs	19
40FW278126P	2 7/8"	10' 6"	60.80 lbs	19
40FW278144P	2 7/8"	12'	69.48 lbs	19
40FW400096P	4"	8'	72.88 lbs	12
40FW400108P	4"	9'	81.99 lbs	12
40FW400126P	4"	10' 6"	95.66 lbs	12
40FW400144P	4"	12'	109.32 lbs	12
40FW658096P	6 5/8"	8'	151.76 lbs	7
40FW658108P	6 5/8"	9'	170.73 lbs	7
40FW658126P	6 5/8"	10' 6"	199.19 lbs	7
40FW658144P	6 5/8"	12'	227.64 lbs	7
40FW858126P	8 5/8"	10' 6"	299.78 lbs	3
40FW858144P	8 5/8"	12'	342.60 lbs	3

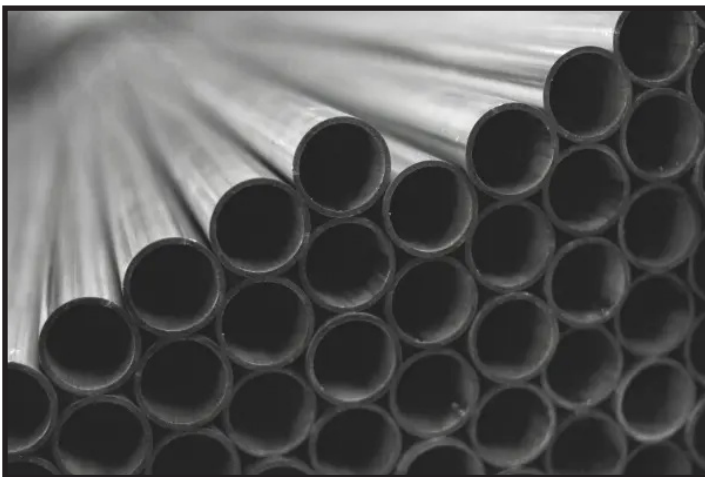

## Pipe - Full Length, Black Powdercoated

US Item #	Size	Gauge	Length	Weight	#/Bundle
16BK138252S	1 3/8"	16	21' S.E.	21.76 lbs	36
16BK138126S	1 3/8"	16	10' 6" S.E.	24.48 lbs	36
16BK158252S	1 5/8"	16	21' S.E.	28.56 lbs	36
16BK158126S	1 5/8"	16	10' 6" S.E.	29.20 lbs	26
C.T.O.	1 5/8"	16	6'	32.85 lbs	26
C.T.O.	1 5/8"	16	7'	38.33 lbs	26
C.T.O.	1 7/8"	16	6'	43.80 lbs	26
C.T.O.	1 7/8"	16	7'	46.32 lbs	19
C.T.O.	1 7/8"	16	8'	52.11 lbs	19
C.T.O.	2 3/8"	16	6'	60.80 lbs	19
C.T.O.	2 3/8"	16	7'	69.48 lbs	19
C.T.O.	2 3/8"	16	8'	72.88 lbs	12
C.T.O.	2 3/8"	16	9'	81.99 lbs	12
C.T.O.	2 3/8"	16	10'	95.66 lbs	12
C.T.O.	2 3/8"	16	12'	109.32 lbs	12
C.T.O.	2 7/8"	16	7'	151.76 lbs	7
C.T.O.	2 7/8"	16	8'	170.73 lbs	7
C.T.O.	2 7/8"	16	9'	199.19 lbs	7
C.T.O.	2 7/8"	16	10'	227.64 lbs	7
C.T.O.	2 7/8"	16	13'	299.78 lbs	3



## Pipe - Cut, Black Powdercoated

US Item #	Size	Gauge	Length	Weight	#/Bundle
16BK158066P	1 5/8"	16	5' 6"	6.11 lbs	61
16BK178072P	1 7/8"	16	6'	7.62 lbs	61
16BK178084P	1 7/8"	16	7'	8.89 lbs	61
16BK178096P	1 7/8"	16	8'	10.16 lbs	61
16BK238072P	2 3/8"	16	6'	9.60 lbs	37
16BK238084P	2 3/8"	16	7'	11.20 lbs	37
16BK238096P	2 3/8"	16	8'	12.80 lbs	37



## Pipe - Black Powdercoated Sch 40

US Item #	Description	Size	Length	Weight	#/Bundle
40BK158252P	Full Length Pipe - Black Powdercoated Sched 40	1 5/8"	21'	47.7 lbs	42
C.T.O.	Full Length Pipe - Black Powdercoated Sched 40	2 3/8"	8'	15.6 lbs	26
40BK238120P	Full Length Pipe - Black Powdercoated Sched 40	2 3/8"	10'	17.6 lbs	26
C.T.O.	Full Length Pipe - Black Powdercoated Sched 40	2 3/8'	12'	43.8 lbs	26
40BK278126P	Full Length Pipe - Black Powdercoated Sched 40	2 7/8"	10' 6"	60.8 lbs	18
C.T.O.	Full Length Pipe - Black Powdercoated Sched 40	2 7/8"	12' 6"	72.4 lbs	18
40BK178096P	Cut Pipe - Black Powdercoated Sched 40	1 7/8"	96"	18.24 lbs	61
40BK238096p	Cut Pipe - Black Powdercoated Sched 40	2 3/8	96"	24.96 lbs	37

## Galvanized Square Tubing

US Item #	Description	Size	Gauge	Length	Weight	#/Bundle
16SQ034288	Galvanized Square Tubing	3/4" x 3/4"	16	24'	15.30 lbs	180
16SQ100288	Galvanized Square Tubing	1" x 1"	16	24'	19.50 lbs	180
16SQ114288	Galvanized Square Tubing	1 1/4" x 1 1/4"	16	24'	23.10 lbs	144
14SQ112288	Galvanized Square Tubing	1 1/2" x 1 1/2"	14	24'	34.60 lbs	81
16SQ112288	Galvanized Square Tubing	1 1/2" x 1 1/2"	16	24'	32.00 lbs	81
14SQ102288P	Galvanized Square Tubing	1" x 2"	14	24'	38.10 lbs	96
16SQ102288P	Galvanized Square Tubing	1" x 2"	16	24'	29.90 lbs	72
11SQ200288	Galvanized Square Tubing	2" x 2"	11	24'	73.20 lbs	25
14SQ200288	Galvanized Square Tubing	2" x 2"	14	24'	60.00 lbs	36
16SQ200288	Galvanized Square Tubing	2" x 2"	16	24'	37.50 lbs	25
C.T.O.	Galvanized Square Tubing	3" x 3"	12.5	24'	92.00 lbs	25
C.T.O.	Galvanized Square Tubing	4" x 4"	12.5	24'	123.00 lbs	16
14SQ203288P	Galvanized Square Tubing	2" x 3"	14	24'	58.60 lbs	25
C.T.O.	Galvanized Square Tubing	2" x 4"	12.5	24'	92.00 lbs	36
14SQ204288P	Galvanized Square Tubing	2" x 4"	14	24'	69.90 lbs	20
11SQ212288	Galvanized Square Tubing	2 1/2" x 2 1/2"	11	24'	92.40 lbs	25
11SQ300288	Galvanized Square Tubing	3" x 3"	11	24'	111.60 lbs	25
11SQ400288	Galvanized Square Tubing	4" x 4"	11	24'	150.10 lbs	16

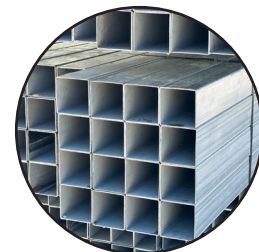

# **PRO LINK** **SUPPLY**

## **Agricultural**

---



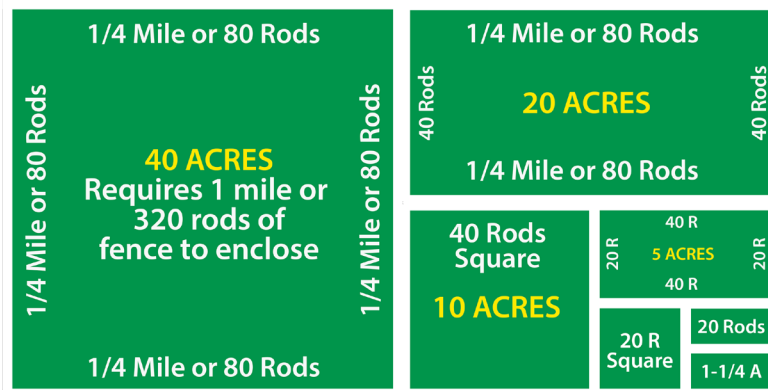
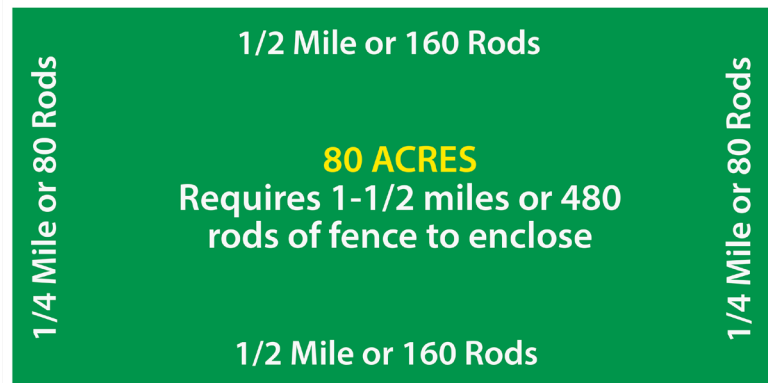
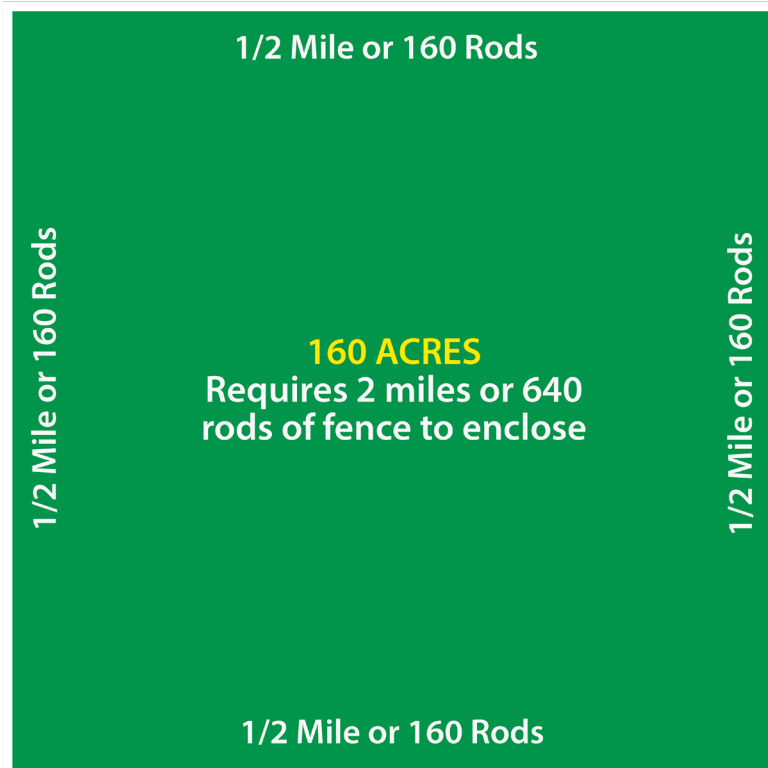

1/4 Mile = 1,320 ft or 80 Rods  
 1/2 Mile = 2,640 ft or 160 Rods  
 1 Mile = 5,280 ft or 320 Rods

1 Rod = 16 1/2 Ft  
 10 Rods = 165 Ft  
 20 Rods = 330 Ft

## How to Read Agricultural Fencing Specs

Use the following example to decode the specifications for all our Farm Fence, Game Fence, and Horse Fence.

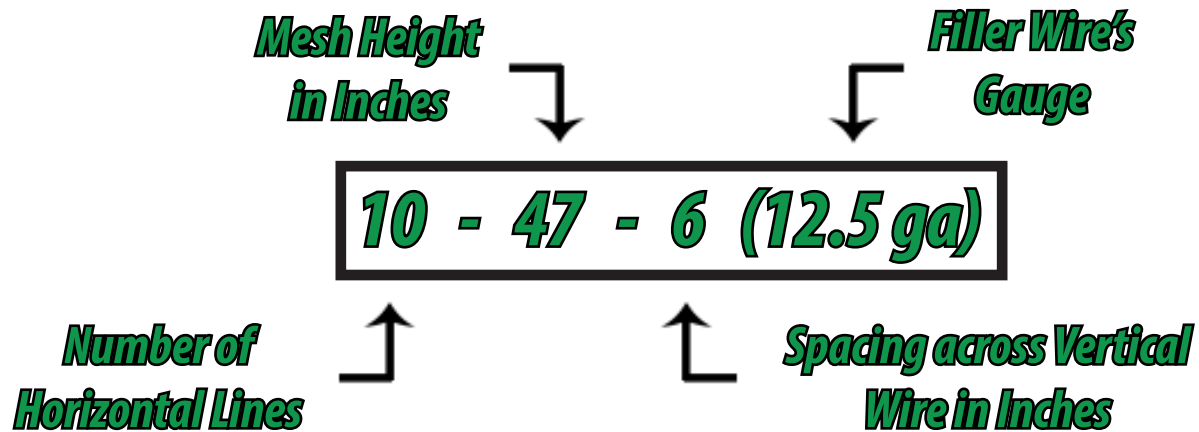

## Agricultural Fence Knots

### Hinge Joint Knot

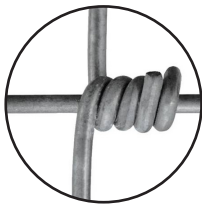

The Hinge Joint Knot is a flexible knot that conforms to the terrain and minimizes damage caused by livestock and weather

### Fixed Knot

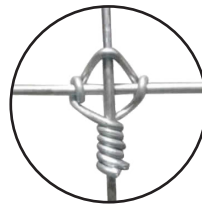

The Fixed Knot is designed to hold the vertical stay wires in place and is durable and resistant to animal damage

### Square Knot

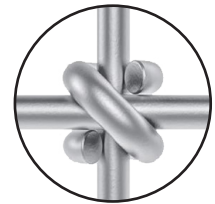

The Square Knot is ideal for the protection of livestock's skin and coats due to its smooth construction.

## Graduated Agricultural Specifications

### Game Fence - Fixed Knot

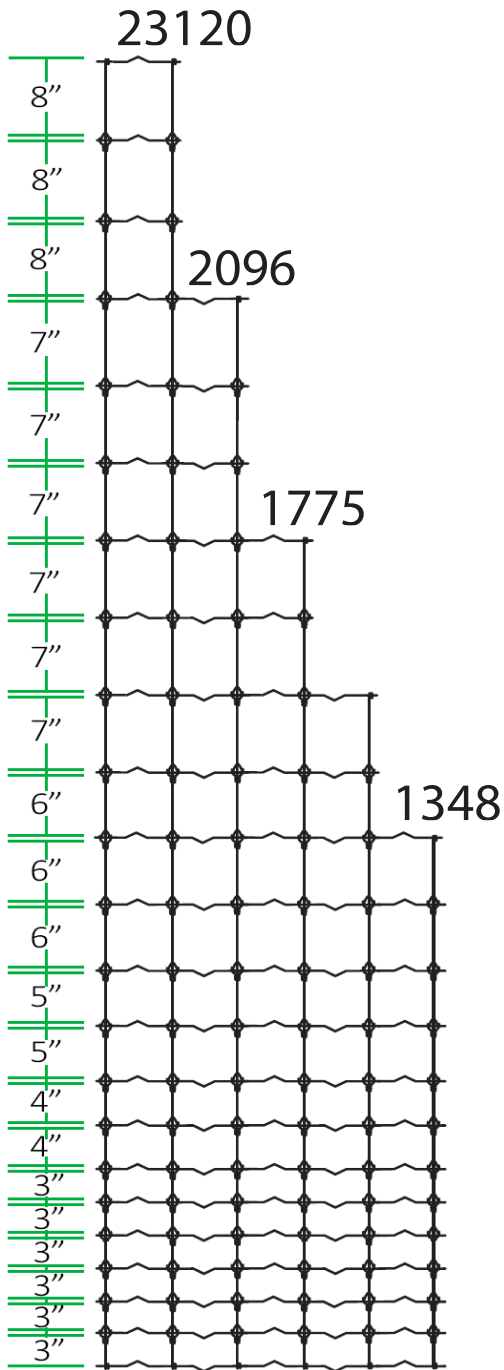

### Field Fence - Hinge Joint Knot

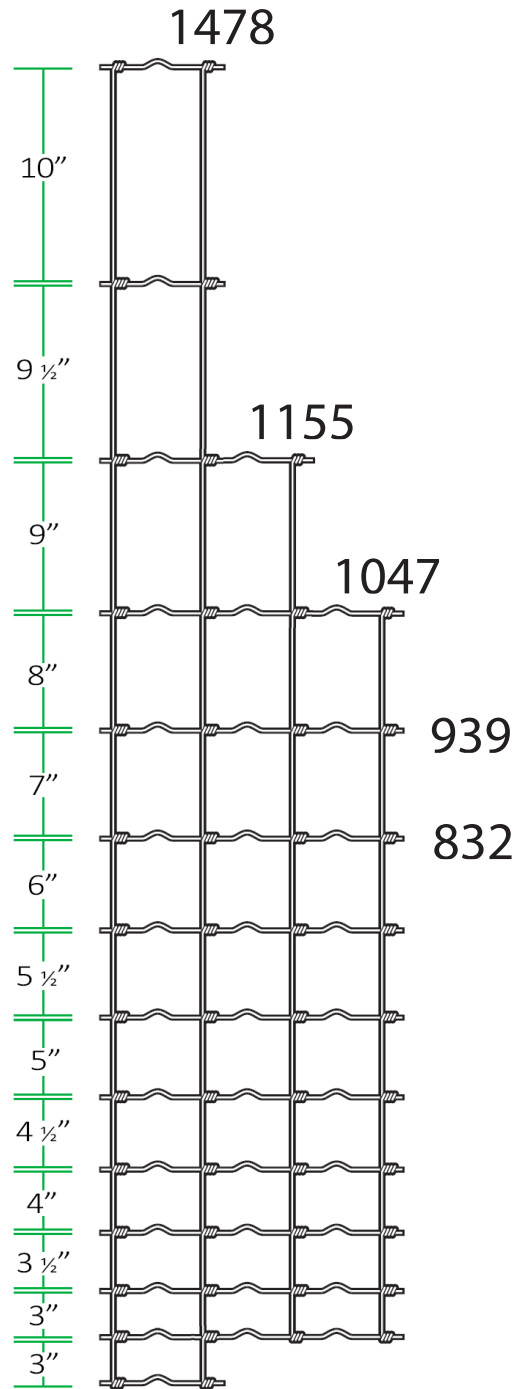

## Filler (C.T.O.)

	Style	Horizontal Wires	Height	Line/Stay Wire Gauge	Edge Wire Gauge	ROLL LENGTH
<b>STANDARD</b>	726-6-12 ½	7	26"	12 ½	10	330'
	832-6-12 ½	8	32"	12 ½	10	330'
	939-6-12 ½	9	39"	12 ½	10	330'
	1047-6-12 ½	10	47"	12 ½	10	330'
	1155-6-12 ½	11	55"	12 ½	10	330'
	832-12-12 ½	8	32"	12 ½	10	330'
	939-12-12 ½	9	39"	12 ½	10	330'
	1047-12-12 ½	10	47"	12 ½	10	330'
	1348-4-12 ½	13	48"	12 ½	10	100'
	1348-4-12 ½	13	48"	12 ½	10	330'
<b>HIGH TENSILE CLASS 3</b>	832-6-14	8	32"	14	12 ½	330'
	939-6-14	9	39"	14	12 ½	330'
	1047-6-14	10	47"	14	12 ½	330'

ASTM Commercial, Class 1, or Class 3 Galvanizing



## Farm Fence

CAD Item #	US Item #	Description	Weight	Unit (ft)	#/P
18000	AF11556FFLG	1155-6 Low Carb Galv. Farm Fence (12 1/2 Ga.)	213 lbs	Roll (330)	9
18002	AF10476CGFF	1047-6 Low Carb Galv. Farm Fence (12 1/2 Ga.)	194 lbs	Roll (330)	9
18003	C.T.O.	1047-6 Low Carb Galv. Farm Fence (12 1/2 Ga.)	95 lbs	Roll (165)	16
18004	AF9396CGFF	939-6 Low Carb Galv. Farm Fence (12 1/2 Ga.)	168 lbs	Roll (330)	9
18006	AF8326CGFF	832-6 Low Carb Galv. Farm Fence (12 1/2 Ga.)	148 lbs	Roll (330)	9
18033	AF257116FFGA	2571-6 Low Carb Galv. Farm Fence (14 1/2 Ga.)	114 lbs	Roll (165)	9
18010	AF147812HTFF	1478-6 High Tensile Class 3 Galv. Farm Fence (12 1/2 Ga.)	265 lbs	Roll (330)	9
18011	C.T.O.	1478-12 High Tensile Class 3 Galv. Farm Fence (12 1/2 Ga.)	165 lbs	Roll (330)	9
18012	AF10476HTFF	1047-6 High Tensile Class 3 Galv. Farm Fence (12 1/2 Ga.)	190 lbs	Roll (330)	9
18014	AF93963CLFF	939-6 High Tensile Class 3 Galv. Farm Fence (12 1/2 Ga.)	168 lbs	Roll (330)	9
18016	AF83263CLFF	832-6 High Tensile Class 3 Galv. Farm Fence (12 1/2 Ga.)	148 lbs	Roll (330)	9
18030	C.T.O.	1047-6 High Tensile Class 3 Galv. Farm Fence (14 1/2 Ga.)	120 lbs	Roll (330)	9
18032	C.T.O.	939-6 High Tensile Class 3 Galv. Farm Fence (14 1/2 Ga.)	106 lbs	Roll (330)	9

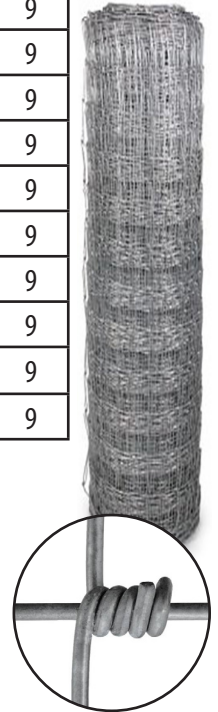

## Game Fence

CAD Item #	US Item #	Description	Weight	Unit (ft)	#/P
18102	AF20966GAME	2096-6 High Tensile Class 3 Galv. Solid Lock (12 1/2 Ga.)	396 lbs	Roll (330)	4
18104	AF20961GAME	2096-12 High Tensile Class 3 Galv. Solid Lock (12 1/2 Ga.)	264 lbs	Roll (330)	1
18106	AF17756GAME	1775-6 High Tensile Class 3 Galv. Solid Lock (12 1/2 Ga.)	327 lbs	Roll (330)	6
18108	AF17751GAME	1775-12 High Tensile Class 3 Galv. Solid Lock (12 1/2 Ga.)	243 lbs	Roll (330)	6
18110	AF10606GAME	1060-6 High Tensile Class 3 Galv. Solid Lock (12 1/2 Ga.)	210 lbs	Roll (330)	6
18112	C.T.O.	1060-12 High Tensile Class 3 Galv Solid Lock (12 1/2 Ga.)	305 lbs	Roll (660)	4
18035	C.T.O.	1478-6 High Tensile Class 3 Galv. Solid Lock (14 1/2 Ga.)	105 lbs	Roll (165)	16
18036	C.T.O.	1478-6 High Tensile Class 3 Galv. Solid Lock (14 1/2 Ga.)	210 lbs	Roll (330)	11



## Crimped Lawn Fence (Imported)

CAD Item #	US Item #	Description	Weight	Unit (ft)	#/P
18360	C.T.O.	36" Class 3 Galv. Crimped Lawn Fence (12 1/2 Ga.)	74 lbs	Roll (100)	9
18362	AF48100CRIMP	48" Class 3 Galv. Crimped Lawn Fence (12 1/2 Ga.)	98 lbs	Roll (100)	9
18364	C.T.O.	60" Class 3 Galv. Crimped Lawn Fence (12 1/2 Ga.)	122 lbs	Roll (100)	9
18366	AF72100CRIMP	72" Class 3 Galv. Crimped Lawn Fence (12 1/2 Ga.)	146 lbs	Roll (100)	9



## Multi-Purpose Mesh (Imported)

CAD Item #	US Item #	Description	Weight	Unit (ft)	#/P
18260	AF3650WELD	36" x 50' Galv. Multi-Purpose Mesh (14 Ga.)	24 lbs	Roll (50)	16
18264	AF4850WELD	48" x 50' Galv. Multi-Purpose Mesh (14 Ga.)	32 lbs	Roll (50)	16
18268	AF6050WELD	60" x 50' Galv. Multi-Purpose Mesh (14 Ga.)	40 lbs	Roll (50)	16
18272	AF7250WELD	72" x 50' Galv. Multi-Purpose Mesh (14 Ga.)	48 lbs	Roll (50)	16
18262	AF3614WELD	36" x 100' Galv. Multi-Purpose Mesh (14 Ga.)	48 lbs	Roll (100)	9
18266	AF4814WELD	48" x 100' Galv. Multi-Purpose Mesh (14 Ga.)	64 lbs	Roll (100)	9
18270	AF6014WELD	60" x 100' Galv. Multi-Purpose Mesh (14 Ga.)	80 lbs	Roll (100)	9
18274	AF7214WELD	72" x 100' Galv. Multi-Purpose Mesh (14 Ga.)	96 lbs	Roll(100)	9

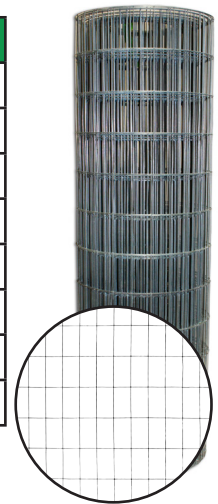

## Horse Fence

CAD Item #	US Item #	Description	Weight	Unit (ft)	#/P
18180	AF48100HORSE	1348-2 (4" x 2") Galv. Stablenmesh (12 1/2 Ga.)	122 lbs	Roll (100)	9
18180SP	C.T.O.	1348-2 (4" x 2") Galv. Stablenmesh (12 1/2 Ga.)	242 lbs	Roll (200)	4
18182	AF60100HORSE	1660-2 (4" x 2") Galv. Stablenmesh (12 1/2 Ga.)	151 lbs	Roll (100)	9
18182SP	C.T.O.	1660-2 (4" x 2") Galv. Stablenmesh (12 1/2 Ga.)	302 lbs	Roll (200)	4
18190	AF72100HORSE	1972-2 (4" x 2") Galv. Stablenmesh (12 1/2 Ga.)	169 lbs	Roll (100)	9
18184	AF48100HORBK	1348-2 (4" x 2") BLACK Stablenmesh (12 1/2 Ga.)	122 lbs	Roll (100)	8
18186	AF60100HORBK	1660-2 (4" x 2") BLACK Stablenmesh (12 1/2 Ga.)	151 lbs	Roll (100)	8

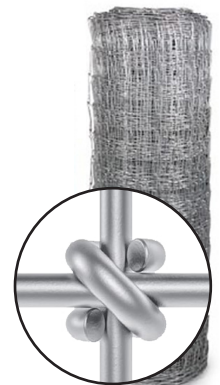

## Sheep & Goat Fence

CAD Item #	US Item #	Description	Weight	Unit (ft)	#/P
18140	AFT134841SGF	1348-4 Sheep & Goat Fence (12 1/2 Ga.) - 100 ft Roll	80 lbs	Roll (100)	16
18142	AFT134843SGF	1348-4 Sheep & Goat Fence (12 1/2 Ga.) - 330 ft Roll	262 lbs	Roll (330)	4

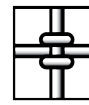
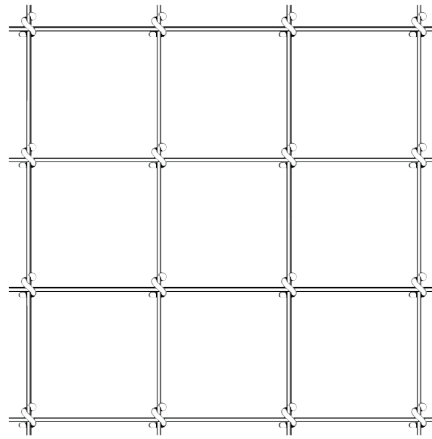

Front



Back

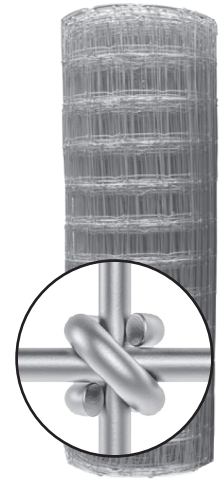

## Poultry Wire/Hex Netting

CAD Item #	US Item #	Description	Weight	Unit (ft)
18200	C.T.O.	36" x 1" Hex Netting	6.30 lbs	Roll (25)
18202	C.T.O.	48" x 1" Hex Netting	8.50 lbs	Roll (25)
18210	C.T.O.	36" x 2" Hex Netting	3.25 lbs	Roll (25)
18212	C.T.O.	48" x 2" Hex Netting	4.42 lbs	Roll (25)
18220	C.T.O.	24" x 1" Hex Netting	6.00 lbs	Roll (50)
18222	C.T.O.	36" x 1" Hex Netting	12.60 lbs	Roll (50)
18224	C.T.O.	48" x 1" Hex Netting	17.00 lbs	Roll (50)
18226	C.T.O.	60" x 1" Hex Netting	21.25 lbs	Roll (50)
18228	C.T.O.	72" x 1" Hex Netting	25.50 lbs	Roll (50)
18230	C.T.O.	24" x 2" Hex Netting	4.50 lbs	Roll (50)
18232	C.T.O.	36" x 2" Hex Netting	6.50 lbs	Roll (50)
18234	C.T.O.	48" x 2" Hex Netting	8.84 lbs	Roll (50)
18223	C.T.O.	36" x 1" Hex Netting	10.00 lbs	Roll (100)

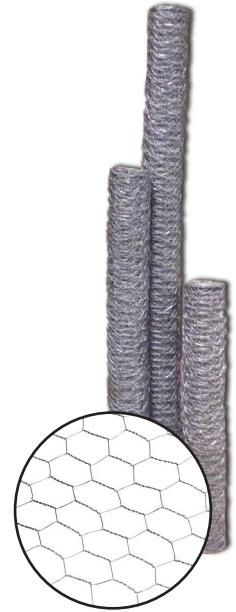

## Deer & Rabbit

CAD Item #	US Item #	Description	Weight	Unit (ft)	#/P
C.T.O.	AF048DEER	48" Deer and Rabbit Fence - 165ft rolls	85 lbs	Roll (165)	14
C.T.O.	AF060DEER	60" Deer and Rabbit Fence - 165ft rolls	99 lbs	Roll (165)	14
C.T.O.	AF072DEER	72" Deer and Rabbit Fence - 165ft rolls	114 lbs	Roll (165)	14

## Stucco Mesh

CAD Item #	US Item #	Description	Weight	Unit (ft)	#/P
18379	C.T.O.	2 x 2 x 48" Stucco Mesh (16 Ga.) - 50 ft Roll	27 lbs	Roll (50)	36
18380	C.T.O.	2 x 2 x 48" Stucco Mesh (16 Ga.) - 112 ft Roll	55 lbs	Roll (112)	9
18382	C.T.O.	2 x 2 x 54" Stucco Mesh (16 Ga.) - 100 ft Roll	55 lbs	Roll (100)	16

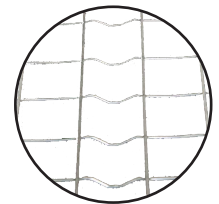

## Fence Stays

CAD Item #	US Item #	Description	Weight	Unit	#/Bundle
18552	BW9342STAY	42" Barb Wire Droppers Fence Stays	41 lbs	Bundle	100
18554	BW9348STAY	48" Barb Wire Droppers Fence Stays	47 lbs	Bundle	100

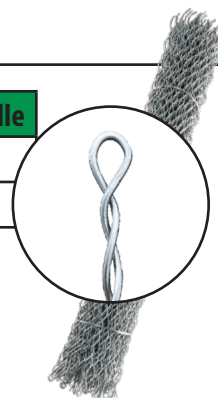

## Merchant Coils/Tension Wire

CAD Item #	US Item #	Description	Weight	Unit	Gauge	Length
18496	TW16010GA	16 Ga. Galv. Merchant Coils	10.00 lbs	Each	16	973 ft
18498	TW14010GA	14 Ga. Galv. Merchant Coils	10.0 lbs	Each	14	580 ft
18502	TW12010GA	12 Ga. Galv. Merchant Coils	10.0 lbs	Each	12	375 ft
18506	AF0910MCGA	9 Ga. Galv. Merchant Coils (.134)	10.0 lbs	Each	9	180 ft
18500	TW14050GA	14 Ga. Galv. Merchant Coils	50.00 lbs	Each	14	2900 ft
18504	TW12050GA	12 Ga. Galv. Merchant Coils	50.00 lbs	Each	12	1875 ft
18508	TW09050GA	9 Ga. Galv. Merchant Coils (.134)	50.00 lbs	Each	9	900 ft
18513	C.T.O.	14 Ga. Black Annealed Merchant Coils	10.0 lbs	Each	14	650 ft
18512	C.T.O.	12 Ga. Black Annealed Merchant Coils	10.0 lbs	Each	12	330 ft
18516	C.T.O.	9 Ga. Black Annealed Merchant Coils	10.0 lbs	Each	9	170 ft
18510	C.T.O.	12 Ga. Black Annealed Merchant Coils	50.00 lbs	Each	12	1650 ft
18518	C.T.O.	9 Ga. Black Annealed Merchant Coils	50.00 lbs	Each	9	850 ft
18530	C.T.O.	12.5 Ga. Galv. Hi-Tensile (Wood Spool)	100.00 lbs	Each	12.5	3800 ft
C.T.O.	TW16050GA	16 ga Tension Wire - 50 lbs	50.00 lbs	Each	16	5500 ft
C.T.O.	TW14050GA	14 ga Tension Wire - 50 lbs	50.00 lbs	Each	14	2929 ft
C.T.O.	TW12050GA	12 ga Tension Wire - 50 lbs	50.00 lbs	Each	12	1684 ft
C.T.O.	TW09050GA	9 ga Tension Wire - 50 lbs	50.00 lbs	Each	9	850 ft
C.T.O.	TW7500COIL	7 ga Coil Spring 1.2 oz -500 ft	42.50 lbs	Each	7	500 ft
C.T.O.	TW09100GA	9 ga Tension Wire - 100 lbs	100.00 lbs	Each	9	1700 ft
C.T.O.	TW71000COIL	7 ga Coil Spring 1.2 oz -1000ft	85.00 lbs	Each	7	1000 ft
C.T.O.	TW09025BK	9 ga Tension Wire - 25 lbs (Black)	25.00 lbs	Each	9	
C.T.O.	TW09025BN	9 ga Tension Wire - 25 lbs (Brown)	25.00 lbs	Each	9	
C.T.O.	TW09025GN	9 ga Tension Wire - 25 lbs (Green)	25.00 lbs	Each	9	
C.T.O.	TW09050BK	9 ga Tension Wire - 50 lbs (Black)	50.00 lbs	Each	9	
C.T.O.	TBK700COIL	7 ga Coil Spring 1.2 oz - 1000ft (Black)	84.00 lbs	Each	7	1000 ft
C.T.O.	TBK750COIL	7 ga Coil Spring 1.2 oz - 500ft (Black)	42.00 lbs	Each	7	500 ft
C.T.O.	TBN750COIL	7 ga Coil Spring 1.2 oz - 500ft (Brown)	42.00 lbs	Each	7	500 ft
C.T.O.	TGN750COIL	7 ga Coil Spring 1.2 oz - 500ft (Green)	42.00 lbs	Each	7	500 ft



## Electric Fence Wire

CAD Item #	US Item #	Description	Weight	Unit	Gauge
18533	C.T.O.	Electric Fence Wire 17 Ga. (4 x 1/4 mile spools per Box)	41lbs	Box	17
18534	C.T.O.	Electric Fence Wire 14 Ga. (2 x 1/4 mile spools per Box)	45lbs	Box	14
18535	C.T.O.	Electric Fence Wire 16 Ga. (4 x 1/4 mile spools per Box)	57lbs	Box	16



## T Posts

CAD Item #	US Item #	Description	Weight	Unit	#/Bundle
18600	TP06PAINT	6' .95 lbs/Foot Painted "T" Post	6.00 lbs	Each	200
18602	TP07PAINT	7' .95 lbs/Foot Painted "T" Post	7.00 lbs	Each	200
18604	TP08PAINT	8' .95 lbs/Foot Painted "T" Post	8.00 lbs	Each	200
C.T.O.	TP6125PAINT	6' heavy painted Green w/ blade	7.50 lbs	Each	200
C.T.O.	TP7125PAINT	7' heavy painted Green w/blade	8.75 lbs	Each	200
C.T.O.	TP8125PAINT	8' heavy painted Green w/blade	10.00 lbs	Each	200
18606	TP06PAINT	9' 1.25 lbs/Foot Painted "T" Post - Heavy w/blade	11.00 lbs	Each	100
18608	TP07PAINT	10' 1.25 lbs/Foot Painted "T" Post - Heavy w/blade	13.00 lbs	Each	100
C.T.O.	TP08PAINT	7' Galv 1.33 lbs/ft	12.00 lbs	Each	200
C.T.O.	TP8133GALV	8' Galv 1.33 lbs/ft	15.00 lbs	Each	200
C.T.O.	TP10133GALV	10' Galv 1.33 lbs/ft	18.50 lbs	Each	200
C.T.O.	C.T.O.	6' Green 1.33 lbs/ft	10.00 lbs	Each	200
C.T.O.	TP7133GALV	7' Green 1.33 lbs/ft	12.00 lbs	Each	200

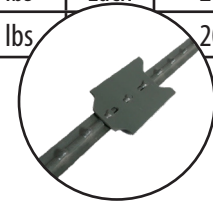

## T-Post Clips

CAD Item #	US Item #	Description	Weight	Approx #
C.T.O.	TPCLIPS	T-post Clips	0.02 lbs	100



## Post Pounders

CAD Item #	US Item #	Description	Weight	Unit
18628	TLPOUNDSML	Small (T Post) Pounder	40 lbs	Each
18630	TLPOUNDMED	4 1/2" x 24" Medium Post Pounder	50 lbs	Each
18632	TLPOUNDLRG	6 5/8" x 24" Large Post Pounder	55 lbs	Each

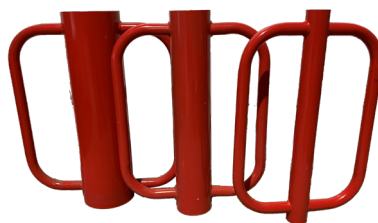

## Barbed Wire

CAD Item #	US Item #	Description	Weight	Unit	Ft / Roll	#/P
06200-GA	BW1548WI	15 1/2 Ga. Class 3 High Tensile Barbed Wire	37 lbs	Roll	1320	27
06202-GA	BW12123BASTM	12 1/2 Ga. Barbless Barbed Wire	70 lbs	Roll	1320	48
06204-GA	C.T.O.	12 1/2 Ga. Canadian Standard Barbed Wire	80 lbs	Roll	1320	27
06206-GA	BW1243BWD	12 1/2 Ga. Class 3 Barbed Wire	81 lbs	Roll	1320	27
C.T.O.	B1245COM	12 1/2 Ga. 4 point 5" Barbed Wire - Commercial	76 lbs	Roll	1320	27
06206-BL	C.T.O.	12 1/2 Ga. Class 3 Barbed Wire- Black	82 lbs	Roll	1320	27
06203-GA	C.T.O.	12 1/2 Ga. Canadian Standard Barbed Wire - Half Roll	40 lbs	Roll	660	84
C.T.O.	BWBK4PTBW	4 Point Vinyl Coated Barb Wire (Black)	85 lbs	Roll		
C.T.O.	BWBN4PTBW	4 Point Vinyl Coated Barb Wire (Brown)	85 lbs	Roll		
C.T.O.	BWGN4PTBW	4 Point Vinyl Coated Barb Wire (Green)	85 lbs	Roll		
06204-IMP	C.T.O.	12 1/2 Ga. Canadian Standard Barbed Wire	80 lbs	Roll	1320	
06206-IMP	C.T.O.	12 1/2 Ga. Class 3 Barbed Wire	81 lbs	Roll	1320	



## Fence Staples

CAD Item #	US Item #	Description	Length	Weight	Unit	Approx Qty
18562	C.T.O.	7/8" Galv. Plastic Pail Fence Staples	7/8"	8 lbs	Pail	2080
18564	C.T.O.	1 1/4" Galv. Plastic Pail Fence Staples (Barbed)	1 1/4"	8 lbs	Pail	752
18566	C.T.O.	1 1/2" Galv. Plastic Pail Fence Staples (Barbed)	1 1/2"	8 lbs	Pail	560
18568	C.T.O.	1 3/4" Galv. Plastic Pail Fence Staples (Barbed)	1 3/4"	8 lbs	Pail	440
18570	C.T.O.	2" Galv. Plastic Pail Fence Staples (Barbed)	2"	8 lbs	Pail	264
18574	C.T.O.	1 1/4" Galv. Plastic Pail Fence Staples (Barbed)	1 1/4"	30 lbs	Pail	2820
18576	C.T.O.	1 1/2" Galv. Plastic Pail Fence Staples (Barbed)	1 1/2"	30 lbs	Pail	2100
18578	C.T.O.	1 3/4" Galv. Plastic Pail Fence Staples (Barbed)	1 3/4"	30 lbs	Pail	1650
18580	C.T.O.	2" Galv. Plastic Pail Fence Staples (Barbed)	2"	30 lbs	Pail	990
18584	C.T.O.	7/8" Galv. Plastic Pail Fence Staples	7/8"	50 lbs	Box	13000
18586	C.T.O.	1 1/4" Galv. Plastic Pail Fence Staples (Barbed)	1 1/4"	50 lbs	Pail	4700
18588	C.T.O.	1 1/2" Galv. Plastic Pail Fence Staples (Barbed)	1 1/2"	50 lbs	Pail	3500
18590	C.T.O.	1 3/4" Galv. Plastic Pail Fence Staples (Barbed)	1 3/4"	50 lbs	Pail	2750
18592	C.T.O.	2" Galv. Plastic Pail Fence Staples (Barbed)	2"	50 lbs	Pail	1650



## Dog Kennels

CAD Item #	US Item #	Description	Weight
17210	DKGA0610131611	10' x 6' Galv Dog Kennel Panel; 1 3/8" Frame 11ga Mesh	180 lbs
17210WD	DKGA0610131611G	10' x 6' Galv Dog Kennel Panel with Door; 1 3/8" Frame 11ga Mesh	180 lbs
C.T.O.	DK61010BKWW	6'h x 6' x 6' Black with 7ga Black Welded Wire (2x4 mesh)	250 lbs

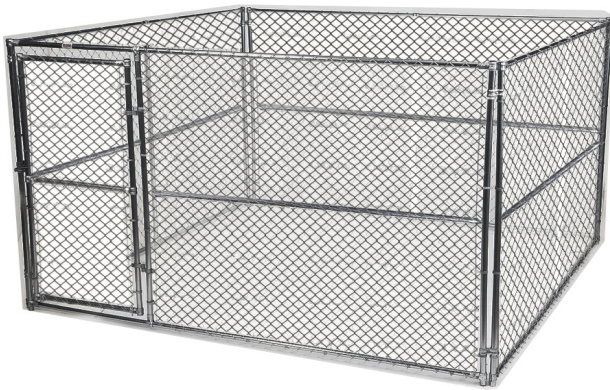

**Standard Dog Kennel Contains:**  
**-3 Kennel Panels**  
**-1 Kennel Panel w/ Door**

## Kennel Accesories

CAD Item #	US Item #	Description	Weight
05088-PS	GH138KENL	1 3/8" Kennel Latch	0.80 lbs
C.T.O.	GH138KENH	1 3/8" Kennel Hinge	0.64 lbs

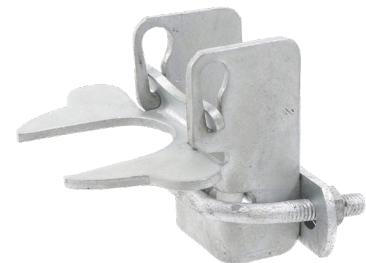

## Round Corner Flat Iron Gate: Meshed

All Farm Gates are 50" tall

Ideal for non-crowding applications such as pastures, field entrances, and coastal/corrosive areas. Galvanized with a powdercoated finish. Welded latch and 36" plated chain included.

**Note:** Gates are 4" less than listed length to accommodate hardware.

CAD Item #	US Item #	Description	Powdercoated	Weight	Unit
18740GN	AGG0442RMEGN	4' Round Corner Mesh Gate (4" x 2")	Green	25.00 lbs	Each
18741GN	AGG0642RMEGN	6' Round Corner Mesh Gate (4" x 2")	Green	35.00 lbs	Each
18742GN	AGG0842RMEGN	8' Round Corner Mesh Gate (4" x 2")	Green	46.00 lbs	Each
18743GN	AGG1042RMEGN	10' Round Corner Mesh Gate (4" x 2")	Green	55.00 lbs	Each
18744GN	AGG1242RMEGN	12' Round Corner Mesh Gate (4" x 2")	Green	65.00 lbs	Each
18745GN	AGG1442RMEGN	14' Round Corner Mesh Gate (4" x 2")	Green	76.00 lbs	Each
18746GN	AGG1642RMEGN	16' Round Corner Mesh Gate (4" x 2")	Green	86.00 lbs	Each
C.T.O.	AGG0442RMESH	4' Round Corner Mesh Gate (4"x2") - 6 Ga	Grey	30.80 lbs	Each
C.T.O.	AGG0642RMESH	6' Round Corner Mesh Gate (4"x2") - 6 Ga	Grey	41.80 lbs	Each
C.T.O.	AGG0842RMESH	8' Round Corner Mesh Gate (4"x2") - 6 Ga	Grey	57.20 lbs	Each
C.T.O.	AGG1042RMESH	10' Round Corner Mesh Gate (4"x2") - 6 Ga	Grey	68.20 lbs	Each
C.T.O.	AGG1242RMESH	12' Round Corner Mesh Gate (4"x2") - 6 Ga	Grey	79.20 lbs	Each
C.T.O.	AGG1442RMESH	14' Round Corner Mesh Gate (4"x2") - 6 Ga	Grey	92.40 lbs	Each
C.T.O.	AGG1642RMESH	16' Round Corner Mesh Gate (4"x2") - 6 Ga	Grey	101.20 lbs	Each

## Square Corner Flat Iron Gate: Meshed

All Farm Gates are 50" tall

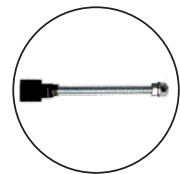
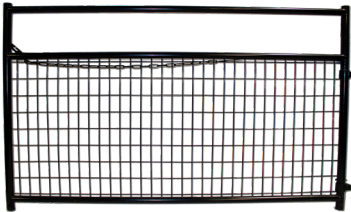

CAD Item #	US Item #	Description	Powdercoated	Weight	Unit
18730BL	AGG04242SQBK	3 1/2' Square Corner Mesh Gate	Black	29.00 lbs	Each
18731BL	AGG0442SQBK	4' Square Corner Mesh Gate	Black	32.00 lbs	Each
18732BL	AGG0642SQBK	6' Square Corner Mesh Gate	Black	42.00 lbs	Each
18733BL	AGG0842SQBK	8' Square Corner Mesh Gate	Black	57.00 lbs	Each
18734BL	AGG1042SQBK	10' Square Corner Mesh Gate	Black	68.00 lbs	Each
18735BL	AGG1242SQBK	12' Square Corner Mesh Gate	Black	81.00 lbs	Each
18736BL	AGG1442SQBK	14' Square Corner Mesh Gate	Black	103.00 lbs	Each
18737BL	AGG1642SQBK	16' Square Corner Mesh Gate	Black	116.00 lbs	Each

## Round Corner Flat Iron Gate: 6-Rail

All Farm Gates are 50" tall

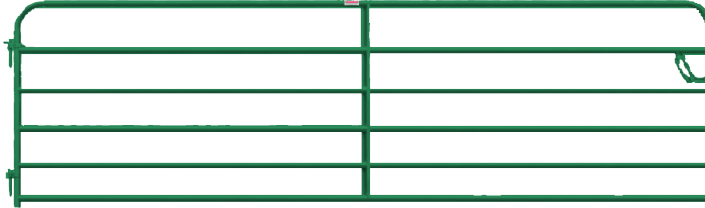

CAD Item #	US Item #	Description	Powdercoated	Height	Weight	Unit
18780GN	AGG045TGN	4' Round Corner Tube Gate	Green	4'	26.00 lbs	Each
18781GN	AGG065TGN	6' Round Corner Tube Gate	Green	6'	35.00 lbs	Each
18782GN	AGG085TGN	8' Round Corner Tube Gate	Green	8'	44.00 lbs	Each
18783GN	AGG105TGN	10' Round Corner Tube Gate	Green	10'	52.00 lbs	Each
18784GN	AGG125TGN	12' Round Corner Tube Gate	Green	12'	60.00 lbs	Each
18785GN	AGG145TGN	14' Round Corner Tube Gate	Green	14'	70.00 lbs	Each
18786GN	AGG165TGN	16' Round Corner Tube Gate	Green	16'	78.00 lbs	Each

## Square Corner Flat Iron Gate: 5-Rail

All Farm Gates are 50" tall

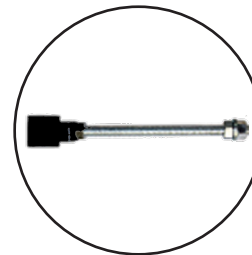

CAD Item #	US Item #	Description	Powdercoated	Height	Weight	Unit
18750BL	AGG045SQBK	4' Square Corner 5 Rail Gate	Black	4'	29.00 lbs	Each
18751BL	AGG065SQBK	6' Square Corner 5 Rail Gate	Black	6'	38.00 lbs	Each
18752BL	AGG085SQBK	8' Square Corner 5 Rail Gate	Black	8'	53.00 lbs	Each
18753BL	AGG105SQBK	10' Square Corner 5 Rail Gate	Black	10'	63.00 lbs	Each
18754BL	AGG125SQBK	12' Square Corner 5 Rail Gate	Black	12'	73.00 lbs	Each
18755BL	AGG145SQBK	14' Square Corner 5 Rail Gate	Black	14'	87.00 lbs	Each
18756BL	AGG165SQBK	16' Square Corner 5 Rail Gate	Black	16'	98.00 lbs	Each

## Square Corner Deer Gate: 72"

CAD Item #	US Item #	Description	Weight	Unit
18761	AGG0604DRMBK	4'W x 72" H (1 5/8") Black Mesh Deer Gate	39.00 lbs	Each
18762	AGG0606DRMBK	6'W x 72" H (1 5/8") Black Mesh Deer Gate	52.50 lbs	Each
18763	AGG0608DRMBK	8'W x 72" H (1 5/8") Black Mesh Deer Gate	70.50 lbs	Each
18764	C.T.O.	10'W x 72" H (1 5/8") Black Mesh Deer Gate	84.25 lbs	Each
18765	C.T.O.	12'W x 72" H (1 5/8") Black Mesh Deer Gate	97.75 lbs	Each

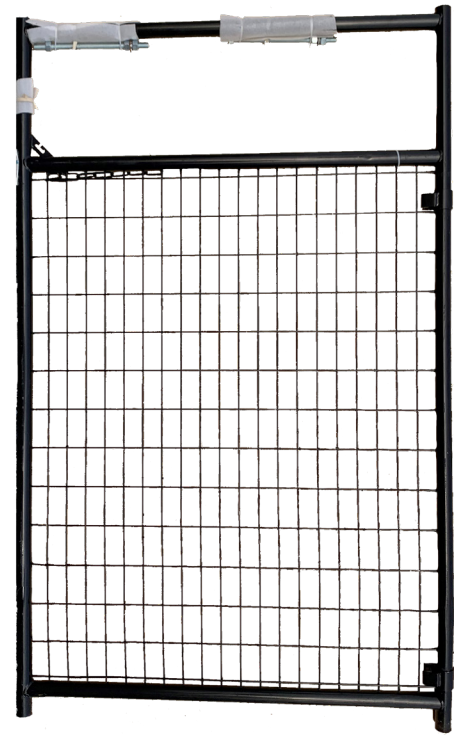

## Square Corner Deer Gate: 90"

CAD Item #	US Item #	Description	Weight	Unit
18771	AGG0804DRMBK	4'W x 90" H (1 5/8") Black Mesh Deer Gate	45.00 lbs	Each
18772	AGG0806DRMBK	6'W x 90" H (1 5/8") Black Mesh Deer Gate	60.50 lbs	Each
18773	AGG0808DRMBK	8'W x 90" H (1 5/8") Black Mesh Deer Gate	82.25 lbs	Each
18774	AGG0810DRMBK	10'W x 90" H (1 5/8") Black Mesh Deer Gate	97.75 lbs	Each
18775	AGG0812DRMBK	12'W x 90" H (1 5/8") Black Mesh Deer Gate	113.00 lbs	Each

## Medium Duty - Flat Iron Corral Panel

CAD Item #	US Item #	Description	Weight	Unit
18676-BL	AF60110MDCPB	Corral Panel, 1 5/8", 5 Rail, 18 Ga (110" x 60")	51 lbs	Each

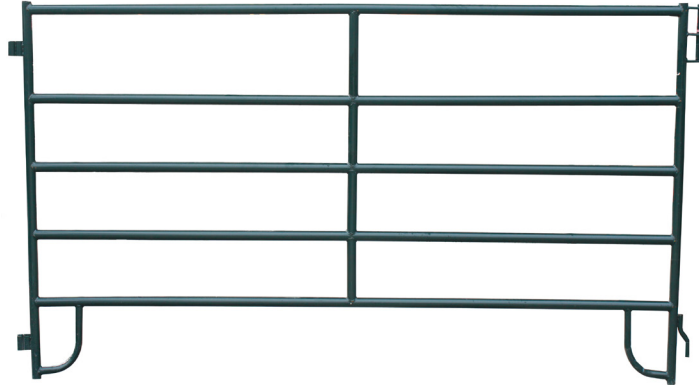

## Medium Duty - Flat Iron Corral Panel with Gate

CAD Item #	US Item #	Description	Weight	Unit
18677-BL	AF60110MDCPG	Walk Through Gate, 5 Rail, 18 Ga (110"W x 60"H x 82"H)	66 lbs	Each

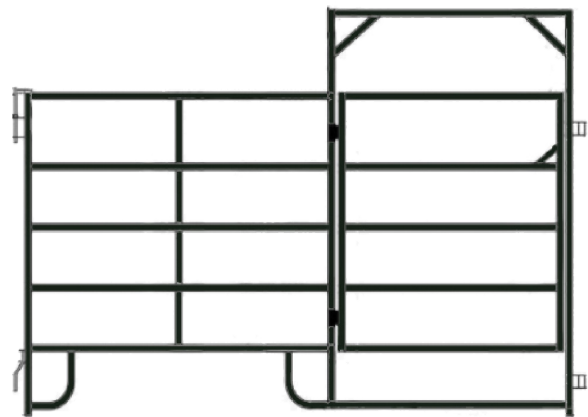

## Light Duty - Flat Iron Corral Panel - Mesh

CAD Item #	US Item #	Description	Weight	Unit
18673-BL	AF5480LDCPMB	Corral Panel, Mesh, 19 Ga (80"W x 54.5 H)	33 lbs	Each



## Light Duty - Flat Iron Corral Panel with Gate - Mesh

CAD Item #	US Item #	Description	Weight	Unit
18688-BL	AF60110MDCP	Walk Through Gate, Mesh, 19 Ga (80"W x 54.5"H x 82"H)	40 lbs	Each

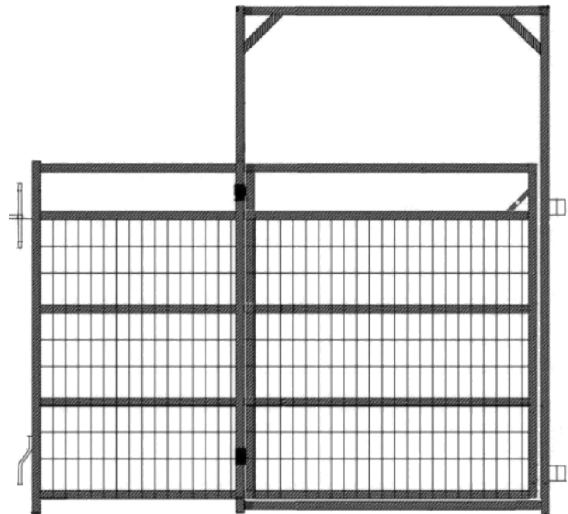

## Light Duty - Flat Iron Corral Panel - 5-Rail

CAD Item #	US Item #	Description	Weight	Unit
18674-BL	AF60110LDPCB	Corral Panel, 5-Rail, 19 Ga (110"W x 60" H)	33 lbs	Each

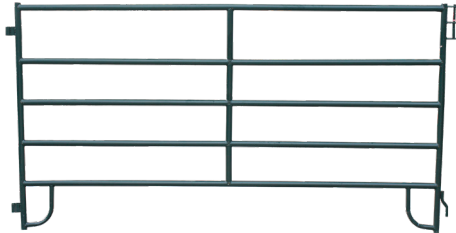

## Light Duty - Flat Iron Corral Panel with Gate - 5-Rail

CAD Item #	US Item #	Description	Weight	Unit
18675BL	AF60110LDPCG	Walk Through Gate, 5 Rail, 19 Ga (110"W x 60"H x 82"H)	42 lbs	Each

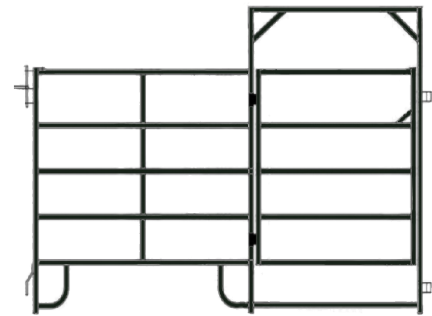

## Light Duty - Flat Iron Corral Panel with Gate - 6-Rail

CAD Item #	US Item #	Description	Weight	Unit
18672GN	C.T.O.	Light Duty, 6 Rail, Corral Panel, 19 Ga (144"W x 60"H) - Green	57 lbs	Each

## Panel Styles

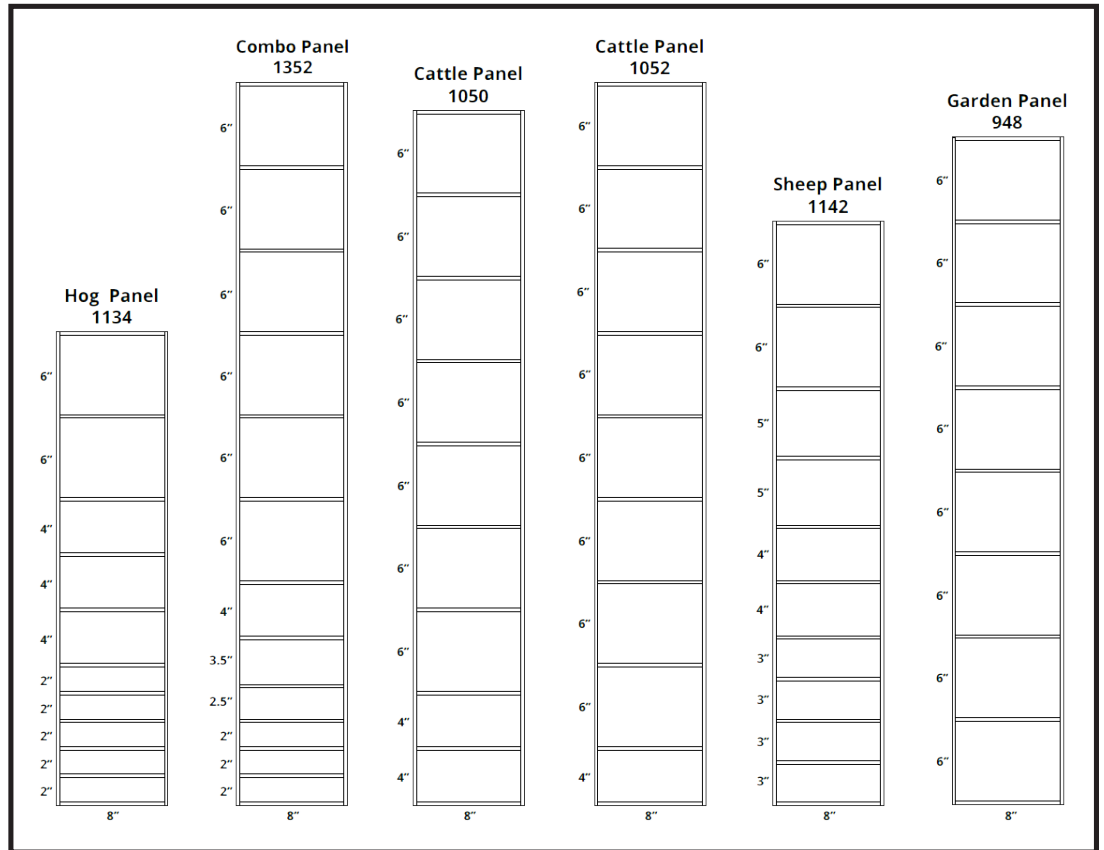

## Cattle Panel

CAD Item #	US Item #	Description	Weight	Unit	#/Bundle
17400	AF5016CATT	Cattle Panel (1050-8-4 x 16')	34 lbs	Each	50

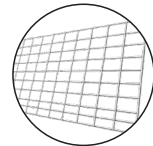

## Galvanized Hog Panel

CAD Item #	US Item #	Description	Weight	Unit	#/Bundle
17410	AF3416HOGP	Hog Panel (1134-8-3.5 x 16')	33 lbs	Each	50

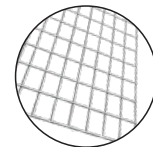

## Fence Panels (Galvanized)

CAD Item #	US Item #	Description	Weight	Gauge	#/Bundle
17420	AF4816UTLPN	Utility Panel (1348-4-6 x 16'W)	51 lbs		50
C.T.O.	AF60192HORPN	Utility Panel (1660-2-6 x 16'W)	74 lbs	6	50
C.T.O.	C.T.O.	Horse Panel (1660-2-6 x 16'W)	50 lbs		50

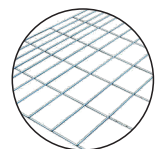

## Latches

CAD Item #	US Item #	Description	Weight	Unit
18660	C.T.O.	Kiwi Latch	0.3 lbs	Each
18667	C.T.O.	Ty-Ten Lok Gate Latch	3 lbs	Each



## Butterfly Latch

CAD Item #	US Item #	Description	Type	#/Bag	Weight
05070-PS	GH1713BUTT	1 3/8" x 1 7/8"	Standard	25	1.2 lbs
05072-PS	GH2313BUTT	1 3/8" x 2 3/8"	Standard	25	1.3 lbs
C.T.O.	GH2315BUTT	2 3/8" x 1 5/8"	Standard	25	1.7 lbs
05076-PS	GH138FBUT	1 3/8" Flat-Back	Flat-Back	25	0.8 lbs
C.T.O.	GBK2313BUTT	2 3/8" x 1 3/8" Butterfly Latch - Steel (Black)	Standard, BL	10	1.0 lbs

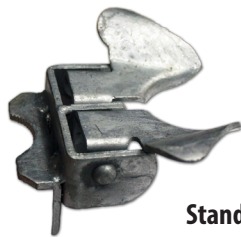

Standard

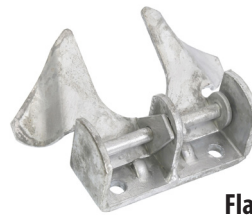

Flatback

## K-Bar Latches

CAD Item #	US Item #	Description	Type	#/Bag	Weight
C.T.O.	GHKBARL	K-Bar Latch - Left	Left	5	3 lbs
C.T.O.	GHKBARR	K-Bar Latch - Right	Right	5	3 lbs
C.T.O.	GHKBARU	K-Bar Latch - Universal	Universal	10	3.2 lbs



## Gate Frame Hinge

CAD Item #	US Item #	Description	Type	#/Bag	Weight
05100-WW	GH1312GFHI	1 3/8" Gate Frame Hinge (5/8")	PS,BL	100	0.40 lbs
C.T.O.	GH1358GFHI	1 3/8" x 5/8" x 1 1/4" Gate Frame Hinge		50	0.48 lbs
C.T.O.	GH10058GFHSQ	1" x 5/8" Square Gate Frame Hinge		50	0.65 lbs
<b>* 3/8" x 2" Bolt and Nut Required (AGR 24)</b>					
05104-WW	GH1758GFHI	1 7/8" Gate Frame Hinge (5/8")	PS	50	0.90 lbs
<b>* 3/8" x 2 1/2" Bolt and Nut Required (AGR 24)</b>					
C.T.O.	GH11258GFHSQ	1 1/2" x 5/8" Square Gate Frame Hinge		50	0.95 lbs
05102-WW	GH1558GFHI	1 5/8" Gate Frame Hinge (5/8")	PS,BL	50	0.50 lbs
<b>* 3/8" x 2 1/4" Bolt and Nut Required (AGR 24)</b>					
C.T.O.	GH20058GFHSQ	2" x 5/8" Square Gate Frame Hinge		50	1.05 lbs
<b>* 3/8" x 3" Bolt and Nut Required (AGR 24)</b>					



## Gate Post Hinge

CAD Item #	US Item #	Description	Type	#/Bag	Weight
05110-WW	GH1358POST	1 3/8" Gate Post Hinge (5/8")	PS	50	0.50 lbs
05112-WW	GH1558POST	1 5/8" Gate Post Hinge (5/8")	PS	50	0.50 lbs
<b>* 3/8" x 2 1/4" Bolt and Nut Required (AGR 24)</b>					
05114-WW	GH1758POST	1 7/8" Gate Post Hinge (5/8")	PS,BL	50	0.70 lbs
<b>* 3/8" x 2 1/2" Bolt and Nut Required (AGR 24)</b>					
05116-WW	GH2358POST	2 3/8" Gate Post Hinge (5/8")	PS,BL	50	0.90 lbs
05120-WW	C.T.O.	3 1/2" Gate Post Hinge (5/8")	PS	50	1.10 lbs
05126-WW	GH58FLBPH	5/8" Pin Flat Back Post Hinge	PS	20	0.50 lbs
C.T.O.	GH20058POST	2" x 5/8" Square Post Hinge	PS	50	0.65 lbs
<b>* 3/8" x 3" Bolt and Nut Required (AGR 24)</b>					
05118-WW	GH2758POST	2 7/8" Gate Post Hinge (5/8")	PS,BL	50	1.10 lbs
C.T.O.	GH21258POST	2 1/2" x 5/8" Square Post Hinge	PS	50	0.95 lbs
<b>* 3/8" x 3 1/2" Bolt and Nut Required (AGR 24)</b>					
C.T.O.	GH30058POST	3" x 5/8" Square Post Hinge	PS	50	1.05 lbs
<b>* 3/8" x 4" Bolt and Nut Required (AGR 24)</b>					



Flatback Pin Hinge

## Fork Latch

CAD Item #	US Item #	Description	Type	#/Bag	Weight
05010-WW	GH1313FLGS	1 3/8" x 1 3/8" Fork Latch	PS	25	0.80 lbs
05011-WW	C.T.O.	1 3/8" x 1 5/8" Fork Latch	PS	25	0.80 lbs
05012-XX	GH1317FLGS	1 3/8" x 1 7/8" Fork Latch	PS,BL,MA,AL	25	1.00 lbs
05014-XX	GH1323FLGS	1 3/8" x 2 3/8" Fork Latch	PS,BL,MA	25	1.10 lbs
05016-XX	GH1327FLGS	1 3/8" x 2 7/8" Fork Latch	PS,MA	25	0.80 lbs
05017-PS	GH1517FLGS	1 5/8" x 1 7/8" Fork Latch	PS	25	1.10 lbs
05018-XX	GH1523FLGS	1 5/8" x 2 3/8" Fork Latch	PS,BL,BM,MA	25	1.10 lbs
05020-XX	GH1527FLGS	1 5/8" x 2 7/8" Fork Latch	PS,BL,BM,MA	25	1.50 lbs
05022-XX	C.T.O.	1 5/8" x 3 1/2" Fork Latch	PS,BL,BM,MA	25	1.80 lbs
C.T.O.	GH1540FLGS	1 5/8" x 4" Fork Latch		25	1.20 lbs
C.T.O.	GH1727FLGS	1 7/8" x 2 7/8" Fork Latch		25	1.10 lbs
C.T.O.	GH1317FLGI	1 3/8" x 1 7/8" Fork Latch	GI	25	1.40 lbs
C.T.O.	GH1323FLGI	1 3/8" x 2 3/8" Fork Latch	GI	25	1.40 lbs
C.T.O.	GH1517FLGI	1 5/8" x 1 7/8" Fork Latch	GI	25	1.50 lbs
C.T.O.	GH1523FLGI	1 5/8" x 2 3/8" Fork Latch	GI	25	1.55 lbs
C.T.O.	GH1527FLGI	1 5/8" x 2 7/8" Fork Latch	GI	25	1.61 lbs
C.T.O.	GH1540FLGI	1 5/8" x 4" Fork Latch	GI	25	2.00 lbs
C.T.O.	GH1717FLGI	1 7/8" x 1 7/8" Fork Latch	GI	25	1.42 lbs
C.T.O.	GH1723FLGI	1 7/8" x 2 3/8" Fork Latch	GI	25	1.60 lbs
C.T.O.	GH1727FLGI	1 7/8" x 2 7/8" Fork Latch	GI	25	1.70 lbs
C.T.O.	GH1740FLGI	1 7/8" x 4" Fork Latch	GI	25	1.70 lbs



## Fork Latch - Fork Only

CAD Item #	US Item #	Description	Type	Weight
05004-PS	GH138FKPS	1 3/8" Fork	Standard	0.40 lbs
05005-PS	GH158FKPS	1 5/8" Fork	Standard	0.60 lbs
05006-PS	GH178FKPS	1 7/8" Fork	Standard	0.80 lbs
05007-PS	GH238FKPS	2 3/8" Fork	Standard	1.00 lbs
05008-PS	GH278FKPS	2 7/8" Fork	Standard	1.20 lbs
C.T.O.	GH658FKPS	6 5/8" Fork	Standard	1.27 lbs
C.T.O.	GH100SQFL	1" Square Fork	Square	0.30 lbs
C.T.O.	GH112SQFL	1 1/2" Square Fork	Square	0.38 lbs
C.T.O.	GH200SQFL	2" Square Fork	Square	0.43 lbs
C.T.O.	GH212SQFL	2 1/2" Square Fork	Square	0.51 lbs

## Collars & Flatbacks

CAD Item #	US Item #	Description	Type	Weight
05002-PS	GH138COL	1 3/8" Two Piece Collar for Fork Latch	2-Piece	0.40 lbs
05003-PS	GH158COL	1 5/8" Two Piece Collar for Fork Latch	2-Piece	0.60 lbs
C.T.O.	GH178COL	1 7/8" Two Piece Collar for Fork Latch	2-Piece	0.50 lbs
05009-PS	GH138FBFB	Flat Back Bracket	Flatback	0.30 lbs
C.T.O.	GH100SQCL	1" Square Collar	Square	0.30 lbs
C.T.O.	GH112SQCL	1 1/2" Square Collar	Square	0.45 lbs
C.T.O.	GH200SQCL	2" Square Collar	Square	0.60 lbs



## Swivel Wheels

CAD Item #	US Item #	Description	Type	Weight
05820-PS	GH138SWSG	1 3/8" (Frame)	Frame	4.65 lbs
05822-PS	GH158SWSG	1 5/8" (Frame)	Frame	4.75 lbs
C.T.O.	GH178SWSG	1 7/8" Frame - Swivel Wheel	Frame	5.00 lbs
C.T.O.	GHFLATSWSG	Flatback Swivel Wheel	Flatback	5.40 lbs
05824-PS	GH006SGRW	1 5/8" x 1 7/8" Single Wheel	Standard	2.81 lbs
C.T.O.	GHSGLPWHEE	Single Pivot Wheel	Single Pivot	6.00 lbs



## Lag Screws

CAD Item #	US Item #	Description	#/Bag	Weight	Unit
05210-PS	GH5841LAGB	5/8" x 4 1/2" Lag Screw	100	1 lbs	Each
05212-PS	GH586LAGB	5/8" x 6" Lag Screw	100	1 lbs	Each
05222-PS	C.T.O.	3/4" x 6" Lag Screw	100	1 lbs	Each



## Hanger Bolts

CAD Item #	US Item #	Description	#/Bag	Weight	Unit
C.T.O.	GH5841HIHB	5/8" x 4 1/2" Hinge Hanger Bolt	100	0.63 lbs	Each
05172-WS	GH586HIHB	5/8" x 6" Hanger Bolt	100	1.00 lbs	Each
C.T.O.	GH588HIHB	5/8" x 8" Hanger Bolt	50	1.00 lbs	Each
05176-WS	GH5810HIHB	5/8" x 10" Hanger Bolt	50	1.00 lbs	Each
05178-WS	GH5812HIHB	5/8" x 12" Hanger Bolt	50	1.00 lbs	Each
05182-XX	GH346HBS	3/4" x 6" Hanger Bolt	50	1.00 lbs	Each
05184-WO	GH349HBS	3/4" x 9" Hanger Bolt	25	1.00 lbs	Each
05188-XX	GH3412HIHB	3/4" x 12" Hanger Bolt	25	1.00 lbs	Each
05194-WO	GH109HBS	1" x 9" Hanger Bolt	25	1.00 lbs	Each



## Carriage Bolts (with nut)

CAD Item #	US Item #	Description	Type	#/Bag	Weight
06070-PS	FG3200BOLT	3/8" x 2" Carriage Bolt		100	0.01 lbs
06072-WW	FG3214BOLT	3/8" x 2 1/4" Carriage Bolt	PS,BL	100	0.01 lbs
06074-PS	FG3212BOLT	3/8" x 2 1/2" Carriage Bolt		100	0.01 lbs
06078-WW	FG3300BOLT	3/8" x 3" Carriage Bolt	PS,BL	100	0.01 lbs
06082-WW	FG3312BOLT	3/8" x 3 1/2" Carriage Bolt	PS,BL	100	0.01 lbs
06086-PS	FG3400BOLT	3/8" x 4" Carriage Bolt		100	0.01 lbs
06090-PS	FG5114BOLT	5/16" x 1 1/4" Carriage Bolt	PS,BL	100	0.01 lbs
06092-PS	C.T.O.	5/16" x 1 1/2" Carriage Bolt		100	0.01 lbs
06098-PS	FG5212BOLT	5/16" x 2 1/2" Carriage Bolt		100	0.01 lbs
06099-PS	FG5212BOLT	5/8" x 2 1/2" Carriage Bolt		100	0.01 lbs
C.T.O.	FBK5114BOLT	*5/16" x 1 1/4" Carriage Bolt	BL	2000	0.04 lbs
C.T.O.	FBK516NUTS	5/16"-18 Finished Hex Nut	BL	2000	0.01 lbs
C.T.O.	FBK3214BOLT	3/8" x 2 1/4" Carriage Bolt	BL	1000	0.09 lbs
C.T.O.	FBK3300BOLT	3/8" x 3" Carriage Bolt	BL	1000	0.11 lbs
C.T.O.	FBK3312BOLT	3/8" x 3 1/2" Carriage Bolt	BL	1000	0.12 lbs
C.T.O.	FBK380NUTS	3/8"-16 Finished Hex Nut	BL	1000	0.02 lbs



## Gripples

CAD Item #	US Item #	Description	Weight	#/Bag
18650	C.T.O.	Small Gripples (17-13Ga)	1.10 lbs	20
18652	C.T.O.	Medium Gripples (14-10Ga)	1.25 lbs	20
18654	C.T.O.	Large Gripples (10-7.5Ga)	2.25 lbs	20



## Farm Gate Accessories

CAD Item #	US Item #	Description	Weight
10022	AGGHINGBLT	Hinge Bolts for Farm Gates	2.00 lbs
18759BL	AGGBKCP	Plastic Caps for Black Farm Gates	0.20 lbs



# PROLINK SUPPLY

## Residential Gates



## Gates - Single Swing (16 Ga frame)

CAD Item #	US Item #	Description	Opening	Height	Weight	Mesh Gauge
C.T.O.	SGGA0442131611	Residential Single Swing Gate - Galvanized	42"	4'	20.00 lbs	11
C.T.O.	SGGA0404131611	Residential Single Swing Gate - Galvanized	48"	4'	23.00 lbs	11
C.T.O.	SGGA0405131611	Residential Single Swing Gate - Galvanized	60"	4'	29.00 lbs	11
C.T.O.	SGGA0542131611	Residential Single Swing Gate - Galvanized	42"	5'	25.00 lbs	11
C.T.O.	SGGA0504131611	Residential Single Swing Gate - Galvanized	48"	5'	29.00 lbs	11
C.T.O.	SGGA0505131611	Residential Single Swing Gate - Galvanized	60"	5'	35.75 lbs	11
C.T.O.	SGGA0642131611	Residential Single Swing Gate - Galvanized	42"	6'	30.00 lbs	11
C.T.O.	SGGA0604131611	Residential Single Swing Gate - Galvanized	48"	6'	34.50 lbs	11
C.T.O.	SGGA0605131611	Residential Single Swing Gate - Galvanized	60"	6'	43.00 lbs	11
C.T.O.	SGBK0442131609	Residential Single Swing Gate - Black Powder Coated	42"	4'	20.00 lbs	9
C.T.O.	SGBK0404131609	Residential Single Swing Gate - Black Powder Coated	48"	4'	23.00 lbs	9
C.T.O.	SGBK0405131609	Residential Single Swing Gate - Black Powder Coated	60"	4'	29.00 lbs	9
C.T.O.	SGBK0542131609	Residential Single Swing Gate - Black Powder Coated	42"	5'	25.00 lbs	9
C.T.O.	SGBK0504131609	Residential Single Swing Gate - Black Powder Coated	48"	5'	29.00 lbs	9
C.T.O.	SGBK0505131609	Residential Single Swing Gate - Black Powder Coated	60"	5'	35.75 lbs	9
C.T.O.	SGBK0642131609	Residential Single Swing Gate - Black Powder Coated	42"	6'	30.00 lbs	9
C.T.O.	SGBK0604131609	Residential Single Swing Gate - Black Powder Coated	48"	6'	34.50 lbs	9
C.T.O.	SGBK0605131609	Residential Single Swing Gate - Black Powder Coated	60"	6'	43.00 lbs	9

## Gates - Double Drive (16 Ga frame)

CAD Item #	US Item #	Description	Opening	Height	Weight	Mesh Gauge
C.T.O.	DGGA0410131611	Residential Double Drive Gate - Galvanized	10'	4'	58.00 lbs	11
C.T.O.	DGGA0412131611	Residential Double Drive Gate - Galvanized	12'	4'	69.00 lbs	11
C.T.O.	DGGA0510131611	Residential Double Drive Gate - Galvanized	10'	5'	72.00 lbs	11
C.T.O.	DGGA0512131611	Residential Double Drive Gate - Galvanized	12'	5'	86.00 lbs	11
C.T.O.	DGGA0610131611	Residential Double Drive Gate - Galvanized	10'	6'	86.00 lbs	11
C.T.O.	DGGA0612131611	Residential Double Drive Gate - Galvanized	12'	6'	103.00 lbs	11
C.T.O.	DGBK0410131609	Residential Double Drive Gate - Black Powder Coated	10'	4'	58.00 lbs	9
C.T.O.	DGBK0412131609	Residential Double Drive Gate - Black Powder Coated	12'	4'	69.00 lbs	9
C.T.O.	DGBK0510131609	Residential Double Drive Gate - Black Powder Coated	10'	5'	72.00 lbs	9
C.T.O.	DGBK0512131609	Residential Double Drive Gate - Black Powder Coated	12'	5'	86.00 lbs	9
C.T.O.	DGBK0610131609	Residential Double Drive Gate - Black Powder Coated	10'	6'	86.00 lbs	9
C.T.O.	DGBK0612131609	Residential Double Drive Gate - Black Powder Coated	12'	6'	103.00 lbs	9

# PROLINK SUPPLY

## Gate Hardware



## Rubber Wheels

CAD Item #	US Item #	Description	Material	Length	Weight	/ Bundle
C.T.O.	GH658GWBB	6" x 5/8" axle Ground Wheel Ball Bearing (P.S. Hub)	PS	6"	2.00 lbs	6
C.T.O.	GH858GWBB	8" x 5/8" axle Ground Wheel Ball Bearing (P.S. Hub)	PS	6"	2.80 lbs	6
C.T.O.	GH858HAHW	8" x 5/8" axle HD Aluminum Hub Wheel	AL	8"	3.60 lbs	6

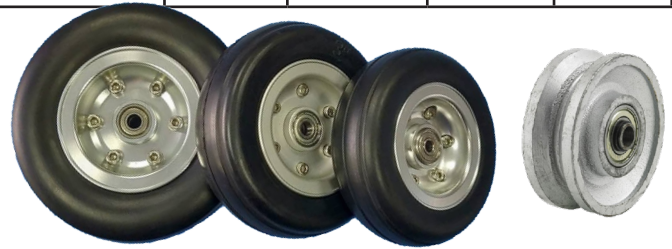

## Single Wheels & Assemblies

CAD Item #	US Item #	Description	Material	Length	Weight	/ Bundle
05824-PS	GH006SGRW	1 5/8" x 1 7/8" Single Wheel	PS		2.81 lbs	4
C.T.O.	GHSGLPWHEE	Single Pivot Wheel			6.00 lbs	4
C.T.O.	GH1586SWCWA	1 5/8" with 6" Wheel & Axle	PS	6"	4.80 lbs	4
C.T.O.	GH1588SWCWA	1 5/8" with 8" Wheel & Axle	PS	8"	6.00 lbs	4
C.T.O.	GH1786SWCWA	1 7/8" with 6" Wheel & Axle	PS	6"	4.82 lbs	4
C.T.O.	GH1788SWCWA	1 7/8" with 8" Wheel & Axle	PS	8"	7.23 lbs	4



## Double Wheel Assembly

CAD Item #	US Item #	Description	Material	Weight	/ Bundle
05842-PS	C.T.O.	1 5/8" or 1 7/8" Frame (12" x 8")	PS	11.5 lbs	4



## V-Groove Wheels & Track

CAD Item #	US Item #	Description	Material	Weight	/ Bundle
C.T.O.	GH400VGIW	4" V-Groove Wheel - Iron	Iron	3.00 lbs	4
C.T.O.	GH600VGIW	6" V-Groove Wheel - Iron	Iron	7.00 lbs	4
C.T.O.	GH600VGSW	6" V-Groove Wheel - Solid Steel	PS	11.80 lbs	4
C.T.O.	GHVT120PLT	Galvanized V-Track with Plate 120"	PS	58.00 lbs	1
C.T.O.	GHVT236JBLT	Galvanized V-Track with J-Bolt 236"	PS	116.00 lbs	1
C.T.O.	GHVT236TAB	Galvanized V-Track with Tabs 236"	PS	116.00 lbs	1



## Swivel Wheels

CAD Item #	US Item #	Description	Material	Fits Pipe Size	Weight	/ Box
05820-PS	GH138SWSG	1 3/8" (Frame)	PS	1 3/8"	4.65 lbs	4
05822-PS	GH158SWSG	1 5/8" (Frame)	PS	1 5/8"	4.75 lbs	4
C.T.O.	GH178SWSG	1 7/8" Frame - Swivel Wheel		1 7/8"	5.00 lbs	4
C.T.O.	GHFLATSWSG	Flatback Swivel Wheel		N/A	5.40 lbs	4



## Wheel Carriers

CAD Item #	US Item #	Description	Material	Wheel Size	Weight	/ Box
05832-PS	C.T.O.	1 5/8" Frame, 8" Wheel	PS	8"	7.0 lbs	4
C.T.O.	GH15176DWCR	1 5/8" or 1 7/8" (6") Double Wheel Carrier	PS	6"	8.80 lbs	4
C.T.O.	GH15178DWCR	1 5/8" or 1 7/8" (8") Double Wheel Carrier	PS	8"	11.50 lbs	4
C.T.O.	GH15178DWCHD	1 5/8" or 1 7/8" (8") - Heavy Duty Double Wheel	PS	8"	9.70 lbs	4
C.T.O.	GH15176DWCN	1 5/8" or 1 7/8" Narrow Double Wheel Carrier (6")	PS	6"	5.90 lbs	4
C.T.O.	GH15178DWCN	1 5/8" or 1 7/8" Narrow Double Wheel Carrier (8")	PS	8"	9.53 lbs	4
C.T.O.	GH15178DWCVR	1 5/8" or 1 7/8" Double Wheel Carrier 6" V-Groove/ 8" Rubber		8"	12.73 lbs	1
C.T.O.	GH15178DWCRT	1 5/8" or 1 7/8" Double Wheel Carrier (8") - Rough Terrain		8"	13.52 lbs	1

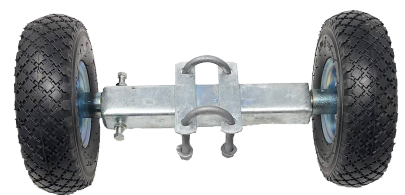

## Farm Gate Trim

CAD Item #	US Item #	Description	Material	Height	Weight	/ Bundle
10022	AGGHINGBLT	Hinge Bolts for Farm Gates			2.00 lbs	
18759BL	AGGBKCP	Plastic Caps for Black Farm Gates			0.20 lbs	



## Hanger Bolts

CAD Item #	US Item #	Description	#/Bag	Weight	Unit
C.T.O.	GH5841HIHB	5/8" x 4 1/2" Hinge Hanger Bolt	100	0.63 lbs	Each
05172-WS	GH586HIHB	5/8" x 6" Hanger Bolt	100	1.00 lbs	Each
C.T.O.	GH588HIHB	5/8" x 8" Hanger Bolt	50	1.00 lbs	Each
05176-WS	GH5810HIHB	5/8" x 10" Hanger Bolt	50	1.00 lbs	Each
05178-WS	GH5812HIHB	5/8" x 12" Hanger Bolt	50	1.00 lbs	Each
05182-XX	GH346HBS	3/4" x 6" Hanger Bolt	50	1.00 lbs	Each
05184-WO	GH349HBS	3/4" x 9" Hanger Bolt	25	1.00 lbs	Each
05188-XX	GH3412HIHB	3/4" x 12" Hanger Bolt	25	1.00 lbs	Each
05194-WO	GH109HBS	1" x 9" Hanger Bolt	25	1.00 lbs	Each



## Lag Screws

CAD Item #	US Item #	Description	#/Bag	Weight	Unit
05210-PS	GH5841LAGB	5/8" x 4 1/2" Lag Screw	100	1 lbs	Each
05212-PS	GH586LAGB	5/8" x 6" Lag Screw	100	1 lbs	Each
05222-PS	C.T.O.	3/4" x 6" Lag Screw	100	1 lbs	Each



## Collars & Flatbacks

CAD Item #	US Item #	Description	Type	Weight
05002-PS	GH138COL	1 3/8" Two Piece Collar for Fork Latch	2-Piece	0.40 lbs
05003-PS	GH158COL	1 5/8" Two Piece Collar for Fork Latch	2-Piece	0.60 lbs
C.T.O.	GH178COL	1 7/8" Two Piece Collar for Fork Latch	2-Piece	0.50 lbs
05009-PS	GH138FBFB	Flat Back Bracket	Flatback	0.30 lbs
C.T.O.	GH100SQCL	1" Square Collar	Square	0.30 lbs
C.T.O.	GH112SQCL	1 1/2" Square Collar	Square	0.45 lbs
C.T.O.	GH200SQCL	2" Square Collar	Square	0.60 lbs



## Fork Latch

CAD Item #	US Item #	Description	Type	#/Bag	Weight
05010-WW	GH1313FLGS	1 3/8" x 1 3/8" Fork Latch	PS	25	0.80 lbs
05011-WW	C.T.O.	1 3/8" x 1 5/8" Fork Latch	PS	25	0.80 lbs
05012-PS	GH1317FLGS	1 3/8" x 1 7/8" Fork Latch	PS	25	1.00 lbs
05012-BL	GBK1317FLGS	1 3/8" x 1 7/8" Fork Latch	BL	25	1.00 lbs
05012-WW	C.T.O.	1 3/8" x 1 7/8" Fork Latch	MA,AL	25	1.00 lbs
05014-PS	GH1323FLGS	1 3/8" x 2 3/8" Fork Latch	PS	25	1.10 lbs
05014-BL	GBK1323FLGS	1 3/8" x 2 3/8" Fork Latch	BL	25	1.10 lbs
05014-MA	C.T.O.	1 3/8" x 2 3/8" Fork Latch	MA	25	1.10 lbs
05016-PS	GH1327FLGS	1 3/8" x 2 7/8" Fork Latch	PS	25	0.80 lbs
05016-MA	C.T.O.	1 3/8" x 2 7/8" Fork Latch	MA	25	0.80 lbs
05017-WW	GH1517FLGS	1 5/8" x 1 7/8" Fork Latch	PS	25	1.10 lbs
05018-PS	GH1523FLGS	1 5/8" x 2 3/8" Fork Latch	PS	25	1.10 lbs
05018-BL	GBK1523FLGS	1 5/8" x 2 3/8" Fork Latch	BL	25	1.10 lbs
05018-WW	C.T.O.	1 5/8" x 2 3/8" Fork Latch	BM,MA	25	1.10 lbs
05020-PS	GH1527FLGS	1 5/8" x 2 7/8" Fork Latch	PS	25	1.50 lbs
05020-BL	GBK1527FLGS	1 5/8" x 2 7/8" Fork Latch	BL	25	1.50 lbs
05020-WW	GH1527FLGS	1 5/8" x 2 7/8" Fork Latch	PBM,MA	25	1.50 lbs
05022-WW	C.T.O.	1 5/8" x 3 1/2" Fork Latch	PS,BL,BM,MA	25	1.80 lbs
C.T.O.	GH1540FLGS	1 5/8" x 4" Fork Latch	PS	25	1.20 lbs
C.T.O.	GH1727FLGS	1 7/8" x 2 7/8" Fork Latch	PS	25	1.10 lbs
C.T.O.	GH1317FLGI	1 3/8" x 1 7/8" Fork Latch	GI	25	1.40 lbs
C.T.O.	GH1323FLGI	1 3/8" x 2 3/8" Fork Latch	GI	25	1.40 lbs
C.T.O.	GH1517FLGI	1 5/8" x 1 7/8" Fork Latch	GI	25	1.50 lbs
C.T.O.	GH1523FLGI	1 5/8" x 2 3/8" Fork Latch	GI	25	1.55 lbs
C.T.O.	GH1527FLGI	1 5/8" x 2 7/8" Fork Latch	GI	25	1.61 lbs
C.T.O.	GH1540FLGI	1 5/8" x 4" Fork Latch	GI	25	2.00 lbs
C.T.O.	GH1717FLGI	1 7/8" x 1 7/8" Fork Latch	GI	25	1.42 lbs
C.T.O.	GH1723FLGI	1 7/8" x 2 3/8" Fork Latch	GI	25	1.60 lbs
C.T.O.	GH1727FLGI	1 7/8" x 2 7/8" Fork Latch	GI	25	1.70 lbs
C.T.O.	GH1740FLGI	1 7/8" x 4" Fork Latch	GI	25	1.70 lbs
05000-PS	GH138FBFL	Flat Back Fork Latch with 1 3/8" Fork	PS	50	0.60 lbs



## Fork Latch - Fork Only

CAD Item #	US Item #	Description	Type	Length	#/Bag	Weight
05004-WW	GH138FKPS	1 3/8" Fork	PS	1 3/8"	100	0.4 lbs
05005-WW	GH158FKPS	1 5/8" Fork	PS	1 5/8"	100	0.6 lbs
05006-WW	GH178FKPS	1 7/8" Fork	PS	1 7/8"	100	0.8 lbs
05007-WW	GH238FKPS	2 3/8" Fork	PS	2 3/8"	100	1 lbs
05008-WW	GH278FKPS	2 7/8" Fork	PS	2 7/8"	50	1.2 lbs
C.T.O.	GH658FKPS	6 5/8" Fork		6 5/8"	10	1.27 lbs
C.T.O.	GH100SQFL	1" Square Fork		1"	50	0.30 lbs
C.T.O.	GH112SQFL	1 1/2" Square Fork		1 1/2"	50	0.38 lbs
C.T.O.	GH200SQFL	2" Square Fork		2"	50	0.43 lbs
C.T.O.	GH212SQFL	2 1/2" Square Fork		2 1/2"	50	0.51 lbs



## Three Piece Fork Latches

CAD Item #	US Item #	Description	Type	Length	#/Bag	Weight
C.T.O.	GH13133PFLS	1 3/8" x 1 3/8" 3-pc Fork Latch -Steel	PS	1 3/8"	25	0.80 lbs
C.T.O.	GH13173PFLS	1 3/8" x 1 7/8" 3-pc Fork Latch -Steel	PS	1 7/8"	25	0.80 lbs
C.T.O.	GH13233PFLS	1 3/8" x 2 3/8" 3-pc Fork Latch -Steel	PS	2 3/8"	25	0.91 lbs

## Heavy Walk Latches

CAD Item #	US Item #	Description	Type	Length	#/Bag	Weight
C.T.O.	GH27157HWGL	2 7/8" x 1 5/8" or 1 7/8" Heavy Walk Latch	PS	2 7/8"	12	4.00 lbs
C.T.O.	GH4157HWGL	4" x 1 5/8" or 1 7/8" Heavy Walk Latch	PS	4"	8	4.10 lbs

## Misc. Latches

CAD Item #	US Item #	Description	Type	Length	#/Bag	Weight
18667	C.T.O.	Ty-Ten Lok Gate Latch		1 3/8"		3.00 lbs
18660	C.T.O.	Kiwi Latch		1 7/8"		0.30 lbs
C.T.O.	GHKANTSLAM	Kant-Slam			1	6.00 lbs
C.T.O.	GH101ULGL	UL-101 Weld-on Uni-Latch	Weld-on		20	1.30 lbs
C.T.O.	GH103ULGL	UL-103 Bolt-on Uni-Latch	Bolt-on		20	1.40 lbs
05132-PS	GH1713GRAVH	1 7/8" x 1 3/8" Gravity Hinge	PS	1 7/8"	20, 10	2.70 lbs
05134-PS	GH2313GRAVH	2 3/8" X 1 3/8" Gravity Hinge	PS	2 3/8"	20, 10	2.80 lbs



## Gate Frame Hinges

CAD Item #	US Item #	Description	Type	Dimensions	#/Bag	Weight
05100-PS	GH1312GFHI	1 3/8" Gate Frame Hinge (5/8")	PS	1 3/8"	100	0.4 lbs
05100-BL	C.T.O.	1 3/8" Gate Frame Hinge (5/8")	BL	1 3/8"	100	0.4 lbs
C.T.O.	GH1358GFHI	1 3/8" x 5/8" x 1 1/4" Gate Frame Hinge		1 3/8"	50	0.48 lbs
05102-PS	GH1558GFHI	1 5/8" Gate Frame Hinge (5/8")	PS	1 5/8"	50	0.5 lbs
05102-BL	C.T.O.	1 5/8" Gate Frame Hinge (5/8")	BL	1 5/8"	50	0.5 lbs
05104-PS	GH1758GFHI	1 7/8" Gate Frame Hinge (5/8")	PS	1 7/8"	50	0.9 lbs
C.T.O.	GH10058GFHSQ	1" x 5/8" Square Gate Frame Hinge		1" x 5/8" Square	50	0.65 lbs
C.T.O.	GH11258GFHSQ	1 1/2" x 5/8" Square Gate Frame Hinge		1 1/2" x 5/8" Square	50	0.95 lbs
C.T.O.	GH20058GFHSQ	2" x 5/8" Square Gate Frame Hinge		2" x 5/8" Square	50	1.05 lbs
C.T.O.	GBK1358GFHI	1 3/8" x 5/8" Gate Frame Hinge (Black)	BL		50	0.48 lbs
C.T.O.	GBK1558GFHI	1 5/8" x 5/8" Gate Frame Hinge (Black)	BL		25	0.57 lbs
C.T.O.	GBK1758GFHI	1 7/8" x 5/8" Gate Frame Hinge (Black)	BL		25	0.60 lbs
C.T.O.	GBK10058GFHI	1" x 5/8" Square Gate Frame Hinge (Black) - pair	BL	1" x 5/8" Square	20	0.59 lbs
C.T.O.	GBK11258GFHI	1 1/2" x 5/8" Square Gate Frame Hinge (Black) - pair	BL	1 1/2" x 5/8" Square	20	0.76 lbs
05126-PS	GH58FLBPH	Flat Back Pin Hinge (5/8")	PS	2 3/8"	50	1.10 lbs



## K-Bar Latches

CAD Item #	US Item #	Description	Type	#/Bag	Weight
C.T.O.	GHKBARL	K-Bar Latch - Left	Left	5	3.00 lbs
C.T.O.	GHKBARR	K-Bar Latch - Right	Right	5	3.00 lbs
C.T.O.	GHKBARU	K-Bar Latch - Universal	Universal	10	3.20 lbs



## Bogey Latches

CAD Item #	US Item #	Description	Type	Dimensions	#/Bag	Weight
C.T.O.	GH138BGYL	1 3/8" Bogey Latch		1 3/8"	10	2.90 lbs
C.T.O.	GH158BGYL	1 5/8" - 1 7/8" Bogey Latch			2	7.30 lbs
C.T.O.	GH178HDDL	1 7/8" Heavy Duty Bogey Latch		1 7/8"	4	15.00 lbs

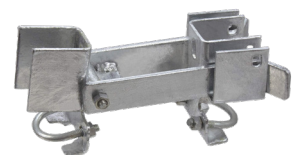

## Gate Post Hinges

CAD Item #	US Item #	Description	Type	Dimensions	#/Bag	Weight
05110-WW	GH1358POST	1 3/8" Gate Post Hinge (5/8")	PS	1 3/8"	50	0.5 lbs
05112-WW	GH1558POST	1 5/8" Gate Post Hinge (5/8")	PS	1 5/8"	50	0.5 lbs
05114-WW	GH1758POST	1 7/8" Gate Post Hinge (5/8")	PS	1 7/8"	50	0.7 lbs
05114-WW	C.T.O.	1 7/8" Gate Post Hinge (5/8")	BL	1 7/8"	50	0.7 lbs
05116-WW	GH2358POST	2 3/8" Gate Post Hinge (5/8")	PS	2 3/8"	50	0.9 lbs
05116-WW	GH2358POST	2 3/8" Gate Post Hinge (5/8")	BL	2 3/8"	50	0.9 lbs
05118-WW	GH2758POST	2 7/8" Gate Post Hinge (5/8")	PS	2 7/8"	50	1.1 lbs
05118-WW	GH2758POST	2 7/8" Gate Post Hinge (5/8")	BL	2 7/8"	50	1.1 lbs
05120-WW	C.T.O.	3 1/2" Gate Post Hinge (5/8")	PS	3 1/2"	50	1.1 lbs
C.T.O.	GH58FLBPH	5/8" Pin Flat Back Post Hinge		Flat Back	20	0.51 lbs
C.T.O.	GH20058POST	2" x 5/8" Square Post Hinge		2" x 5/8" Square	50	0.65 lbs
C.T.O.	GH21258POST	2 1/2" x 5/8" Square Post Hinge		2 1/2" x 5/8" Square	50	0.95 lbs
C.T.O.	GH30058POST	3" x 5/8" Square Post Hinge		3" x 5/8" Square	50	1.05 lbs
C.T.O.	GBK1758POST	1 7/8" x 5/8" Post Hinge (Black)		1 7/8"	50	0.76 lbs
C.T.O.	GBK2358POST	2 3/8" x 5/8" Post Hinge (Black)		2 3/8"	25	0.85 lbs
C.T.O.	GBK2758POST	2 7/8" x 5/8" Post Hinge (Black)		2 7/8"	25	1.20 lbs
C.T.O.	GBK20058POST	2" x 5/8" Square Post Hinge (Black) -pair		2" x 5/8" Square	20	1.28 lbs
C.T.O.	GBK21258POST	2 1/2" x 5/8" Square Post Hinge (Black) - pair		2 1/2" x 5/8" Square	20	1.46 lbs



## Butterfly Latches

CAD Item #	US Item #	Description	Type	Length	#/Bag	Weight
05070-WW	GH1713BUTT	1 3/8" x 1 7/8"	PS	1 3/8"	25	1.2 lbs
05072-WW	GH2313BUTT	1 3/8" x 2 3/8"	PS	1 3/8"	25	1.3 lbs
C.T.O.	GH2315BUTT	62 3/8" x 1 5/8" Butterfly Latch	PS	2 3/8"	25	1.70 lbs
05076-WW	GH138FBUT	1 3/8" Flatback Butterfly Latch	PS	1 3/8"	25	0.76 lbs
C.T.O.	GBK2313BUTT	2 3/8" x 1 3/8" Butterfly Latch - Steel (Black)	BL	2 3/8"	10	1.00 lbs



## Rolo Latches

CAD Item #	US Item #	Description	Type	Dimensions	#/Bag	Weight
C.T.O.	GH158ROLO	1 5/8" Rolo Latch	GI	1 5/8"	10	2.20 lbs
C.T.O.	GH178ROLO	1 7/8" Rolo Latch	GI	1 7/8"	10	2.20 lbs
C.T.O.	GBK158ROLO	1 5/8" Rolo Latch - (Black)	BL	1 5/8"	10	2.14 lbs
C.T.O.	GBK178ROLO	1 7/8" Rolo Latch - (Black)	BL	1 7/8"	10	2.15 lbs

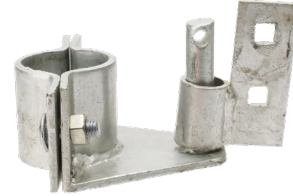

## Frost Free Latches

CAD Item #	US Item #	Description	Type	Length	#/Bag	Weight
05090-WW	GH158FFGL	1 5/8" Frost Free Gate Latch	MA	1 5/8"	10	2.80 lbs
C.T.O.	GH178FFGL	1 7/8" Frost Free Gate Latch	PS	1 7/8"	10	3.00 lbs



## Lock-n-Latch

CAD Item #	US Item #	Description	Type	#/Bag	Weight
C.T.O.	GHOSLNL	Off-Set Lock-n-Latch	Off-set	10	1.50 lbs
C.T.O.	GHRGLNL	Regular Lock-n-Latch	Regular	10	1.50 lbs



## Auto Latches

CAD Item #	US Item #	Description	Type	Length	#/Bag	Weight
C.T.O.	GH1317AUTO	1 3/8" x 1 7/8" Auto Latch	PS	1 7/8"	24	1.10 lbs
C.T.O.	GH1323AUTO	1 3/8" x 2 3/8" Auto Latch	PS	2 3/8"	24	1.20 lbs



## Shut it BadAss Gate Hinges

CAD Item #	US Item #	Description	#/Bag	Weight
C.T.O.	GH3000BADWZ	Original Steel BadAss Gate Hinge	2	2.50 lbs
C.T.O.	GH3300BADWZ	Combo BadAss Gate Hinge w/Aluminum Body	6	2.0 lbs
C.T.O.	GH3600BADWZ	Baby BadAss Gate Hinge	6	1.10 lbs
C.T.O.	GH3700BADWZ	Shut it Bolt-on BadAss (CI3700) Zinc Hinge	2	3.50 lbs
C.T.O.	GH3750BADWZ	Shut it Baby Bolt-on BadAss Zinc Hinge (CI3750)	2	2.0 lbs
C.T.O.	GH3770BADWZ	Shut it Half-Bolt-on BadAss Zinc Hinge (CI3770)	2	2.5 lbs
C.T.O.	GH3850BADWZ	Shut it Self Closing BadAss Hinge (CI3850) Weld-on Zinc	2	5.50 lbs



## Spring Hinges & Closers

CAD Item #	US Item #	Description	#/Bag	Weight
C.T.O.	GH2315SHCOM	1-7/8" - 2-7/8" Post x 1-3/8" - 1-7/8" Gate Frame Commercial Spring Hinge	12	3.00 lbs
C.T.O.	GH400HDSCH	4" Post x 1 3/8" - 1 7/8" Gate Frame Heavy Duty Self Closing Hinge	12	3.00 lbs
C.T.O.	GH1317AUTOG	1 3/8" x 1 7/8" Auto Gate Spring Closer	12	0.83 lbs
C.T.O.	GH1323AUTOG	1 3/8" x 2 3/8" Auto Gate Spring Closer	12	1.00 lbs



## 180° Industrial Hinges

CAD Item #	US Item #	Description	Length	#/Bag	Weight
C.T.O.	GH2318INDS	2 3/8" Industrial Gate Hinge 180°	2 3/8"	10	3.50 lbs
C.T.O.	GH2718INDS	2 7/8" Industrial Gate Hinge 180°	2 7/8"	10	3.30 lbs
C.T.O.	GH3118INDS	3 1/2" Industrial Gate Hinge 180°	3 1/2"	10	3.70 lbs
C.T.O.	GH418INDS	4" Industrial Gate Hinge 180°	3"	10	3.70 lbs
C.T.O.	GH4118INDS	4 1/2" Industrial Gate Hinge 180°	4 1/2"	10	4.00 lbs
C.T.O.	GH6518INDS	6 5/8" Industrial Gate Hinge 180°	6 5/8"	4	6.40 lbs
C.T.O.	GH8518INDS	8 5/8" Industrial Gate Hinge 180°	8 5/8"	4	7.80 lbs

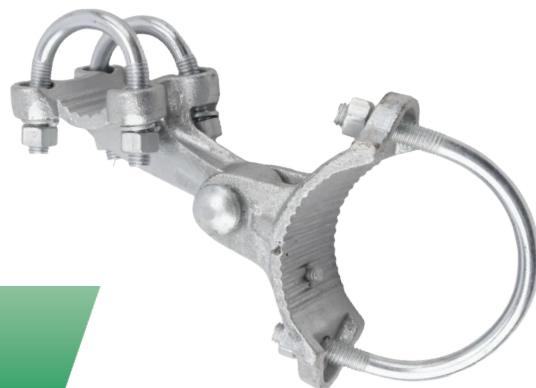

## Galvanized Iron Industrial Hinges

CAD Item #	US Item #	Description	Width	#/Bag	Weight
C.T.O.	GH4157INDGI	4" Industrial Gate Hinge	4"	10	4.70 lbs
C.T.O.	GH65157INDGI	6 5/8" Industrial Gate Hinge	6 5/8"	10	10.30 lbs
C.T.O.	GH85157INDGI	8 5/8" Industrial Gate Hinge	8 5/8"	12	13.10 lbs

## Bulldog Hinges

CAD Item #	US Item #	Description	#/Bag	Weight
C.T.O.	GH23157BULLH	2 3/8" x 1 5/8" or 1 7/8" Bulldog Hinge	12	2.90 lbs
C.T.O.	GH27157BULLH	2 7/8" x 1 5/8" or 1 7/8" Bulldog Hinge	12	2.90 lbs
C.T.O.	GH31157BULLH	3 1/2" x 1 5/8" or 1 7/8" Bulldog Hinge	12	3.20 lbs
C.T.O.	GH4157BULLH	4" x 1 5/8" or 1 7/8" Bulldog Hinge	12	3.30 lbs
C.T.O.	GH41157BULLH	4 1/2" x 1 5/8" or 1 7/8" Bulldog Hinge	12	3.40 lbs
C.T.O.	GH65157BULLH	6 5/8" x 1 5/8" or 1 7/8" Bulldog Hinge	4	5.20 lbs
C.T.O.	GH85157BULLH	8 5/8" x 1 5/8" or 1 7/8" Bulldog Hinge	2	7.00 lbs
C.T.O.	GHFLATBCK	Flat Back Bulldog Hinge	5	4.00 lbs
C.T.O.	GH1517NOSE	Nose Piece for Bulldog Hinge	10	0.80 lbs
C.T.O.	GBK2357BULLH	2 3/8" x 1 5/8" or 1 7/8" Bulldog (Black)	10	2.70 lbs
C.T.O.	GBK2757BULLH	2 7/8" x 1 5/8" or 1 7/8" Bulldog (Black)	10	2.80 lbs
C.T.O.	GBK4157BULLH	4" x 1 5/8" or 1 7/8" Bulldog (Black)	10	3.70 lbs
C.T.O.	GBK6557BULLH	6 5/8" x 1 5/8" or 1 7/8" Bulldog (Black)	4	5.70 lbs



## 180° Attachment

CAD Item #	US Item #	Description	Length	#/Bag	Weight
C.T.O.	GH1518INDBA	1 5/8" Ball Plug	1 5/8"	10	1.00 lbs
C.T.O.	GH1718INDBA	1 7/8" Ball Plug	1 7/8"	10	1.48 lbs
C.T.O.	GH1517INDBA	1 5/8" x 1 7/8" Adapter - 180° Attachment	1 5/8"	10	4.10 lbs



## Industrial Latch Assemblies

CAD Item #	US Item #	Description	Width	#/Bag	Weight
05092-PS	GH158FORK	1 5/8" Industrial Drop Rod - Fork	1 5/8"	25	1.50 lbs
C.T.O.	GH178FORK	1 7/8" Industrial Drop Rod - Fork	1 7/8"	25	1.50 lbs
05093-PS	GH158GUID	1 5/8" Industrial Latch Assembly - Guide	1 5/8"	75	1.00 lbs
C.T.O.	GH178GUID	1 7/8" Industrial Latch Assembly - Guide	1 7/8"	75	1.00 lbs
C.T.O.	GBKGUIDLAS	Residential Latch Assembly - Guide only (Black)		20	0.20 lbs



## Cane Bolts - Cane Only

CAD Item #	US Item #	Description	Length	#/Bag	Weight
C.T.O.	GH1236DROP	1/2" x 36" Cane Bolt - Galvanized	36"	25	1.80 lbs
C.T.O.	GH1244DROP	1/2" x 44" Cane Bolt - Galvanized	44"	25	2.30 lbs



## Residential Latch Assembly

CAD Item #	US Item #	Description	Length	#/Bag	Weight
C.T.O.	GH1336LARD	1 3/8" x 36" Latch Assembly (includes 2 guides)	36"	20	2.00 lbs
C.T.O.	GH1344LARD	1 3/8" x 44" Latch Assembly (includes 2 guides)	44"	20	2.20 lbs
C.T.O.	GHGUIDELAS	Guide Only		20	0.40 lbs
C.T.O.	GBK1344LARD	1 3/8" x 44" Latch Assembly (Black) includes 2 guides	44"	10	3.50 lbs

## Locking Drop Rod

CAD Item #	US Item #	Description	Type	#/Bag	Weight
C.T.O.	GH251RODG	25" Galvanized Drop Rod (1" dia)	GA	5	4.90 lbs
C.T.O.	GBK251RODG	25" Galvanized Drop Rod (1" dia)- (Black)	BL	10	4.90 lbs

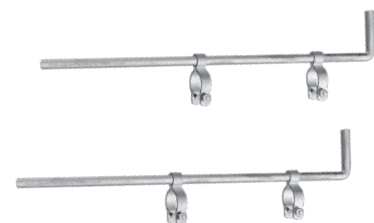

## Gate Rods

CAD Item #	US Item #	Description	Length	#/Bag	Weight
05092-PS	GH4451RODS	5/16" x 44" Gate Rod	44"	25	0.70 lbs
C.T.O.	GH5651RODS	5/16" x 56" Gate Rod	56"	25	0.90 lbs
05093-PS	GH6851RODS	5/16" x 68" Gate Rod	68"	25	1.10 lbs
C.T.O.	GH7251RODS	5/16" x 72" Gate Rod	72"	25	1.20 lbs



## Gate Keepers

CAD Item #	US Item #	Description	Type	#/Bag	Weight
C.T.O.	GH1517GHBGI	1 5/8" or 1 7/8" Gate Keeper - Galv. Iron	GI	20	2.40 lbs
C.T.O.	GH158GHBS	1 5/8" Gate Keeper - Steel	Steel	20	1.70 lbs



## Gate Clips

CAD Item #	US Item #	Description	Length	#/Bag	Weight
C.T.O.	GH1358CLIP	1 3/8" x 5/8" Gate Clip	5/8"	500	0.13 lbs
05760-PS	GH1358CCLIP	1 3/8" x 5/8" "C" Style Gate Clip	5/8"	250, 500	0.13 lbs
C.T.O.	GH1534CLIP	1 5/8" x 3/4" Gate Clip	3/4"	250	0.16 lbs
05764-PS	GH1558CCLIP	1 5/8" x 3/4" "C" Style Gate Clip	3/4"	250	0.14 lbs



## Center Stops

CAD Item #	US Item #	Description	Type	#/Bag	Weight
C.T.O.	GHCNTRSTOP	Center Stop - Galvanized Iron	GI	10	3.10 lbs
C.T.O.	GHFLDCTRPS	Center Stop - Field Type -Steel	PS	12	1.30 lbs



## Single Hole Lock Boxes

CAD Item #	US Item #	Description	Details	#/Bag	Weight
C.T.O.	GH23421LOCKB	1 Hole Lock Box - 2 3/4" Backset, 2 1/8" Hole	1 hole, 2 3/4" Backset	20	0.90 lbs
C.T.O.	GH23821LOCKB	1 Hole Lock Box - 2 3/8" Backset, 2 1/8" Hole	1 hole, 2 3/8" Backset	20	1.10 lbs
C.T.O.	GHBXRHOBOX	Lock Box (K-BXRHO)	K-BXRHO	10	1.20 lbs
C.T.O.	GHBXSIMEEB	Simplex Unican EE-1000 Series K-BXSIM-EE	K-BXSIM-EE	10	2.65 lbs

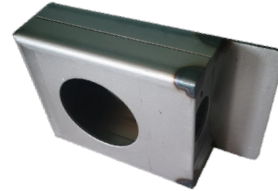

## Double Hole Lock Box

CAD Item #	US Item #	Description	Type	#/Bag	Weight
C.T.O.	GHBXSIMBOX	K-BXSIM Kabailco 1000 & 5000	K-BXSIM	1	2.9 lbs
C.T.O.	GHBXSIMBOX	Trilogy DL-2700 DL-3000	Trilogy	1	2.9 lbs
C.T.O.	GHBXSIMBOX	Code lock 5000	Code lock 5000	1	2.9 lbs



K-BXSIM Kabailco 1000 & 5000



Trilogy DL-2700 DL-3000



Code lock 5000

## TruClose Hinges

CAD Item #	US Item #	Description	#/Bag	Weight
10002	GHTRUHINRG	TruClose Hinge w/2 side legs - TCA1L2S3BT	10	0.74 lbs
10011	GHTRUSHDBK	TruClose Series 3 Hinge TCHD1AS3BT - Heavy (Black)	10	1.23 lbs
C.T.O.	GHTRUSHDWH	TruClose Series 3 Hinge TCHD1AS3WT - Heavy (White)	10	1.23 lbs
C.T.O.	GHTRUHINHD	TruClose Heavy Duty Hinge w/2 side legs-TCHD1AL2S3BT	10	1.23 lbs
C.T.O.	GHTRUMAHDW	TruClose Multi Adjust Heavy Duty Wood/Vinyl -TCHDMA1	10	2.60 lbs
10010	C.T.O.	TruClose Hinge for Round Posts - Heavy Duty	10	



## TruClose Hinges Misc.

CAD Item #	US Item #	Description	Length	#/Bag	Weight
C.T.O.	GHTRUMAHRG	TruClose Multi Adjustable Hinge - TCAMA2RND		10	1.35 lbs
C.T.O.	GHTRUMMABK	TruClose Mini Multi Adjust Hinge (7/8" - 1-1/2" gap) - TCAMA1	1 1/2"	10	0.57 lbs
C.T.O.	GHTRUMMTBK	TruClose Mini Multi Adjust Hinge (7/8" - 2" gap) - TCAMA2	2"	10	0.59 lbs
C.T.O.	GHTRURPHDS	Small TruClose Round Post Hinge TCHDRND1-MK2		10	5.51 lbs
C.T.O.	GHTRURPHDL	Large TruClose Round Post Hinge TCHDRND2-MK2		10	5.51 lbs



TCAMA1



TCHDRND2-MK2

## 180° Hinge and Gate Closer

CAD Item #	US Item #	Description	Details	#/Bag	Weight
C.T.O.	GHTIGER	Locinox Tiger 180° Compact Hinge and Gate Closer	180° Compact	10	5.40 lbs
C.T.O.	GHMSCBK	Mammoth Hydraulic Gate Closer for Heavy Gate	Hydraulic	10	10.40 lbs



'Tiger' on left  
'Mammoth' on right



## MagnaLatch

CAD Item #	US Item #	Description	#/Bag	Weight
C.T.O.	GHMAGSIDEP	Side Pull MagnaLatch - MLSPS2	10	0.27 lbs
05080-BL	GHMAGTOPBK	Top Pull MagnaLatch - (Black) - ML3TPKA	10	1.43 lbs
C.T.O.	GHMAGTOPWH	Top Pull MagnaLatch - (White) - MLTPS2WTBGA	10	1.43 lbs
C.T.O.	GHTRUHINH	TruClose Heavy Duty Hinge w/2 side legs - TCHD1AL2S3BT	10	1.16 lbs

## Round Post Adaptor Kit



CAD Item #	US Item #	Description	Type	#/Bag	Weight
C.T.O.	GHDD002RPAK	Series 2 Round Post Adaptor Kit for MagnaLatch - MLS2RPAKA	Series 2		
05079-BL	GHDD003RPAK	Series 3 Round Post Adaptor Kit for MagnaLatch - ML3RPK	Series 3	10	0.50 lbs

## 2-way Adjustment 180° Surface Mount

CAD Item #	US Item #	Description	#/Bag	Weight
C.T.O.	GBKPUMA	Puma 180° Surface Mount 2-way Adjustable Hinge	10	1.20 lbs



## LokkLatch

CAD Item #	US Item #	Description	#/Bag	Weight
C.T.O.	GHLOKKLATC	LokkLatch Latch only - LLAA	10	0.54 lbs
10054SP	GHLOKKEAKY	LokkLatch with External Access Key -LLAAB	10	0.68 lbs
10074SP	C.T.O.	Lokk Latch Deluxe w/External Access Key-LLDAB	10	
C.T.O.	GHLOKKEAKR	LokkLatch with External Access Key for Round Posts LLABRND	10	0.86 lbs
C.T.O.	GHLOKLDXE	Deluxe LokkLatch with External Access - LLD3KD	6	1.32 lbs
C.T.O.	GHLOKMGKBK	LokkLatch Magnetic Keyed Alike (Black) - LLMKABT	10	0.65 lbs

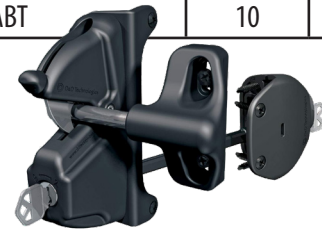

## KWIKFIT - Aluminum Hinge

CAD Item #	US Item #	Description	#/Bag	Weight
C.T.O.	GHKWIKFTBK	Kwik Fit Aluminum (KF3A) Wall or Post Mount - Black	1	1.0 lbs



## Safe-T Line Track Brackets

CAD Item #	US Item #	Description	Length	#/Bag	Weight
05710-XX	GH1715STBU	1 7/8" or 1 5/8" Track Bracket with U-Bolts	1 5/8"	20	2.60 lbs
05712-XX	GH2723STBU	2 7/8" or 2 3/8" Track Bracket with U-Bolts	2 3/8"	20	2.70 lbs
05716-PS	C.T.O.	3 1/2" x 1 5/8"	1 5/8"	20	2.8 lbs
C.T.O.	GH400STBU	4" Track Bracket with U-bolts	4"	20	2.80 lbs
05718-PS	GHFLATSTBU	1 5/8" Flat Back Line Bracket	1 5/8"	20	2.13 lbs
C.T.O.	GHBANDSTBU	Band Type Safety Track Bracket		20	1.00 lbs
C.T.O.	GBK1715STBU	1 7/8" or 1 5/8" Track Bracket with U-Bolts - (Black)	1 5/8"	10	2.60 lbs
C.T.O.	GBK2723STBU	2 7/8" or 2 3/8" Track Bracket with U-Bolts- (Black)	2 3/8"	10	2.70 lbs

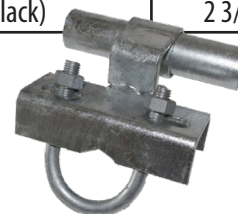

## Gate Stop

CAD Item #	US Item #	Description	#/Bag	Weight
C.T.O.	GHSFTGTSTP	Safety Gate Stop	20	0.60 lbs



## Safe-T Rear Wheels

CAD Item #	US Item #	Description	Material	#/Bag	Weight
05700-PS	GH500TWS	5" Track Wheel	PS	10	2.50 lbs
C.T.O.	GH500WCBS	5" Track Wheel with Bracket	PS	4	4.55 lbs
C.T.O.	GH50017WCBS	5" x 1-7/8" Track Wheel w Clamp on Bracket- Steel	PS	4	5.52 lbs
C.T.O.	GH400WUBN	4" Track Wheel with U-Bolt- Nylon	PS	4	3.50 lbs
C.T.O.	GH500WCBN	5" Track Wheel with Clamp on Bracket- Nylon	PS	4	5.77 lbs
C.T.O.	GH500DBGI	5" Track Wheel with Bracket	GI	4	6.99 lbs
05700-MA	C.T.O.	1 5/8" x 5"	MA	4	4.9 lbs

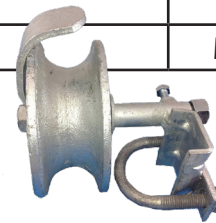

## Clamp on Gate Roller Brackets

CAD Item #	US Item #	Description	Length	#/Bag	Weight
C.T.O.	GH158CBS	1 5/8" Clamp on Gate Roller Bracket	1 5/8"	25	1.0 lbs
C.T.O.	GH178CBS	1 7/8" Clamp on Gate Roller Bracket	1 7/8"	25	1.0 lbs



## Cantilever Receivers

CAD Item #	US Item #	Description	Length	#/Bag	Weight
C.T.O.	GH278CLATC	2 7/8 Cantilever Gate Latch- Lok-n-latch Style	2 7/8"	10	3.53 lbs
C.T.O.	GH400CLATC	4" Cantilever Gate Latch- Lok-n-latch Style	4"	10	3.97 lbs
C.T.O.	GH278LCLAT	2 7/8 Lockable Cantilever Gate Latch Receiver Style	2 7/8"	10	3.53 lbs
C.T.O.	GH400LCLAT	4" Lockable Cantilever Gate Latch Receiver Style	4"	10	3.53 lbs
C.T.O.	GH423ANLAT	4" x 2 3/8" Adjustable Nesting Cantilever Latch	4"	4	5.00 lbs



## Cantilever Rollers

CAD Item #	US Item #	Description	Length	#/Bag	Weight
C.T.O.	GH27823CRNRIWI	2-7/8" Rnd Post C.A.Back w/2-3/8" Nylon Cantilever Roller	2 7/8"	4	12.00 lbs
C.T.O.	GH4238CRNRIWI	4" Round Post P.S.Back w/2-3/8" Nylon Cantilever Roller	4"	4	13.20 lbs
C.T.O.	GH4238CRNSIWI	4" Square Post P.S.Back w/2-3/8" Nylon Cantilever Roller	4"	4	12.00 lbs
C.T.O.	GH6523CRNRIWI	6-5/8" Round Post P.S.Back w/2-3/8" Nylon Cantilever Roller	6 5/8"	4	15.22 lbs
C.T.O.	GH0402CRNRIWI	4" Square Post P.S.Back w/2" Square Nylon Cantilever Roller	4"	4	9.60 lbs
C.T.O.	GH4200CRNRIWI	4" Round Post P.S.Back w/2" Square Nylon Cantilever Roller	4"	4	12.00 lbs
C.T.O.	GH4238CRIRIWI	4" Round Post G.I.Back w/2-3/8" G.I. Cantilever Roller	4"	4	16.54 lbs
C.T.O.	GH2717CRGI	2-7/8" Round Post G.I.Back w/1 7/8" G.I. Cantilever Roller	2 7/8"	4	14.00 lbs
C.T.O.	GH2723CRNRIWI	2-7/8" Round Post G.I. Back w/2-3/8" G.I. Cantilever Roller	2 7/8"	4	16.39 lbs
C.T.O.	GH4238CRCNIWI	4" Round Post G.I. Back w/2-3/8" Nylon Cantilever Roller	4"	4	12.00 lbs
05732-MA	C.T.O.	3 1/2" x 2 3/8" or 1 7/8"		4	16.30 lbs
05732-NY	C.T.O.	3 1/2" x 2 3/8" or 1 7/8"		4	16.30 lbs
05734-MA	C.T.O.	4 1/2" x 2 3/8" or 1 7/8"		4	16.30 lbs
05734-NY	C.T.O.	4 1/2" x 2 3/8" or 1 7/8"		4	16.30 lbs



## Cantilever Covers

CAD Item #	US Item #	Description	Type	#/Bag	Weight
C.T.O.	GHPPCRC	PolyPlastic Cantilever Roller Cover	PolyPlastic	4	4.50 lbs
C.T.O.	GH238CARC	Cantilever Roller Cover - 2 3/8 Nylon Roller	Nylon	4	4.50 lbs
C.T.O.	GHCANRCMAL/GHTBCOVER3	Cantilever Roller Cover - Galv Iron Roller	Iron	4	4.50 lbs
C.T.O.	GH200CARC	Cantilever Roller Cover for 2" Square Roller	Square	4	4.50 lbs

## Cantilever Rollers w/Cover

CAD Item #	US Item #	Description	Length	#/Bag	Weight
C.T.O.	GH23815CRNRIWI	2-3/8" Rnd Pst P.S.Back w/1-5/8" Nylon Cantilever Roller w/Cover	2 3/8"	4	3.90 lbs
C.T.O.	GH4238CRNPCWI	4" Rnd Pst P.S.Back w/2-3/8" Nylon Cantilever Roller w/Cover	4"	4	15.00 lbs
C.T.O.	GH4238CRNICWI	4" Rnd Pst G.I.Back w/2-3/8" Nylon Cantilever Roller -w/Cover	4"	4	14.03 lbs
C.T.O.	GH6523CRNICWI	6 5/8" Round Post P.S.Back w/2-3/8" Nylon Cantilever Roller w/Cover	6 5/8"	4	15.22 lbs

## Hi Motion Cantilever Tracks

CAD Item #	US Item #	Description	Length	Weight
11000	GHTRACKMED	Hi Motion Track - 20' - Medium	20'	80.00 lbs
11030	GHTRACKLRG20	Hi Motion Track - 20' - Large	20'	165.00 lbs
C.T.O.	GHTRACKLRG36	Hi Motion Track - 36' - Large	36'	292.00 lbs
11020	GHTRACKXLG	Hi Motion Track - 20' - X-Large	20'	290.00 lbs

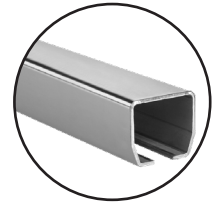

## Hi Motion Cantilever Support Rollers

CAD Item #	US Item #	Description	Type	Weight
11008	GHTROLLEYM	Hi Motion Support Rollers (8 Wheels) - Medium	M	10.00 lbs
11018	GHTROLLEYL	Hi Motion Support Rollers (8 Wheels) - Large	L	25.00 lbs
11028	GHTROLLEYX	Hi Motion Support Rollers (8 Wheels) - X-Large	XL	75.00 lbs
C.T.O.	GHCONVKITL	Comunello to Hi Motion Support Rollers Conversion Kit - Large	Conv. Kit	2.00 lbs



## Hi Motion End Caps w/ Guide Roller

CAD Item #	US Item #	Description	Type	Weight
11007	GHENDCAPME	Hi Motion Carriage - End Cap w/ Guide Roller - Medium	M	2.00 lbs
11017	GHENDCAPLG	Hi Motion Carriage - End Cap w/ Guide Roller - Large	L	4.00 lbs
11027	GHENDCAPXL	Hi Motion Carriage - End Cap w/ Guide Roller - X-Large	XL	12.00 lbs

## Hi Motion Mounting & End Plates

CAD Item #	US Item #	Description	Size	Weight
11006	GHCAPSTMED	Hi Motion End Plate - Medium	M	1.00 lbs
11016	GHCAPSTLRG	Hi Motion End Plate - Large	L	1.00 lbs
11026	GHCAPSTXLG	Hi Motion End Plate - X-Large	XL	2.00 lbs
11009	GHMNTGPLTM	Hi Motion Carriage - Mounting Plate - Medium	M	1.00 lbs
11019	GHMNTGPLTL	Hi Motion Carriage - Mounting Plate - Large	L	2.00 lbs
11029	GHMNTGPLTX	Hi Motion Carriage - Mounting Plate - X-Large	XL	5.00 lbs

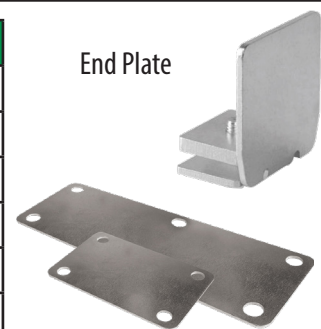

## Hi Motion Gate Limit Stop

CAD Item #	US Item #	Description	Size	Weight
11002	GHLSTOPMED	Hi Motion Gate Limit Stop (End Cup) - Medium	M	2.00 lbs
11012	GHLSTOPLRG	Hi Motion Gate Limit Stop (End Cup) - Large	L	4.00 lbs
11022	GHLSTOPXLG	Hi Motion Gate Limit Stop (End Cup) - X-Large	XL	6.00 lbs



## Hi Motion Clamp-On Mounting Brackets

CAD Item #	US Item #	Description	Size	Weight
11057	GH278CLA	2 7/8" Round Post Clamp on Mounting Bracket for M Support Roller	2 7/8"	2.00 lbs
11058	C.T.O.	2 7/8" flanged Bracket for M Support Roller	2 7/8"	2.25 lbs
C.T.O.	C.T.O.	3 1/2" flanged Bracket for M Support Roller	3 1/2"	
C.T.O.	GH400SCLM	4" Sq. Post Clamp on Mounting Bracket for M Support Roller	4"	2.50 lbs
11054	GH400RCLA	4" Round Post Clamp on Mounting Bracket for L Support Roller	4"	2.50 lbs
11056	GH400SCLA	4" Sq. Post Clamp on Mounting Bracket for L Support Roller	4"	2.50 lbs

## Hi Motion Guide Plate

CAD Item #	US Item #	Description	Type	Weight
C.T.O.	GHMDAGP	Hi Motion Adjustable Weld on Guide Plate 208.1 -Medium	Medium	4.50 lbs
C.T.O.	GHLGAGP	Hi Motion Adjustable Weld on Guide Plate 208.2- Large	Large	5.00 lbs

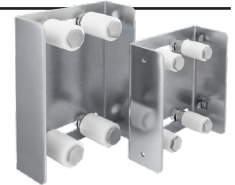

## Hi Motion Cantilever Guide Rollers

CAD Item #	US Item #	Description	Length	Weight
C.T.O.	GH003ROLLER	Guide Roller w/ Bracket (3")	3"	1.00 lbs
C.T.O.	GH006ROLLR	Guide Roller w/ Bracket (6")	6"	2.00 lbs



## Hi Motion Industrial Door Tracks & Rollers

CAD Item #	US Item #	Description	Width	#/Bag	Capacity	Weight
C.T.O.	OHT62624TRCK	626.24 20ft Premium Sliding Galvanized Track for 1-15/16 Rollers	1 15/16"			
C.T.O.	OHT62642TRCK	626.42 20ft Premium Sliding Galvanized Track for 1-11/16 Rollers	1 11/16"	1		
C.T.O.	OHT62655TRCK	626.55 20FT Premium Sliding Galvanized Track 2-1/8 Rollers	2 1/8"	1		
C.T.O.	OHR60124RLLR	601.24 1-5/16 2-Wheel Premium Sliding Track Roller w Bearing		20	66.00 lbs	0.10 lbs
C.T.O.	OHR60224RLLR	602.24 1-5/16 4-Wheel Premium Sliding Track Roller w Bearing		20	110.00 lbs	0.20 lbs
C.T.O.	OHR60442RLLR	604.42 1-11/16 4-Wheel Premium Sliding Track Roller w Bearing		10	550.00 lbs	1.25 lbs
C.T.O.	OHR60455RLLR	604.55 2-1/8 4-Wheel Premium Sliding Track Roller w Bearing		6	880.00 lbs	2.80 lbs



## Hi Motion Clamp-On Mounting Brackets

CAD Item #	US Item #	Description	#/Bag	Weight
C.T.O.	OHA63142TSCM	631.42 Track Support for Ceiling Mounting of 1-11/16 Premium Track	10	0.90 lbs



## Hi Motion Overhead Door Junction

CAD Item #	US Item #	Description	#/Bag	Weight
C.T.O.	OHA63246JUNC	632.42 Junction for Premium Sliding Track	30	1.00 lbs

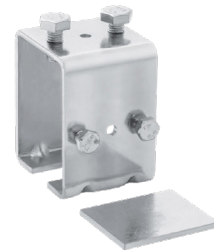

## End Stop Cap

CAD Item #	US Item #	Description	#/Bag	Weight
C.T.O.	OHA63342ESTP	633.42 End Stop Cap for Premium Sliding Track	20	0.20 lbs
C.T.O.	OHA64142UNRG	641.42 Upper Nylon Roller Guide with Fixing Plate	8	0.40 lbs

End Stop Cap



End Stop Cap



## Industrial Door Handles

CAD Item #	US Item #	Description	#/Bag	Weight
C.T.O.	OHA65000HNDL	650.F Handles (Female) for Sliding Track System	10	.30 lbs
C.T.O.	OHA65111HNDL	651.11 Handle (Male) for Sliding Track System	6	1.6 lbs



Male (Left)

Female (Right)



# PRO LINK SUPPLY

## Fittings

---



## Tension Bands - 14 Ga

CAD Item #	US Item #	Description	Material	Width	#/Bag	Weight
04001-PS	FG138TBR	1 3/8" Tension Band	PS	1 3/8"	250	0.10 lbs
04001-BL	FBK138TBR	1 3/8" Tension Band	BL	1 3/8"	250, 50	0.10 lbs
04002-PS	FG158TBR	1 5/8" Tension Band	PS	1 5/8"	250	0.20 lbs
04002-BL	FBK158TBR	1 5/8" Tension Band	BL	1 5/8"	250, 50	0.20 lbs
04003-PS	FG178TBR	1 7/8" Tension Band	PS	1 7/8"	250	0.20 lbs
04003-BL	FBK178TBR	1 7/8" Tension Band	BL	1 7/8"	250, 50	0.20 lbs
04004-PS	FG238TBR	2 3/8" Tension Band	PS	2 3/8"	250	0.20 lbs
04004-BL	FBK238TBR	2 3/8" Tension Band	BL	2 3/8"	250	0.20 lbs
04005-PS	FG278TBR	2 7/8" Tension Band	PS	2 7/8"	100	0.30 lbs
04005-BL	FBK278TBR	2 7/8" Tension Band	BL	2 7/8"	100, 50	0.30 lbs
04006-PS	FG312TBR	3 1/2" Tension Band	PS	3 1/2"	100	0.40 lbs
04006-BL	C.T.O.	3 1/2" Tension Band	BL	3 1/2"	100	0.40 lbs
C.T.O.	FG400TBR	4" Tension Band	PS	4"	100	0.40 lbs
C.T.O.	FBK400TBR	4" Tension Band	BL	4"	50	0.40 lbs
04007-PS	FG412TBR	4 1/2" Tension Band	PS	4 1/2"	100	0.40 lbs
04008-PS	C.T.O.	6 5/8" Tension Band	PS	6 5/8"	50	0.70 lbs



## Heavy Tension Bands - 11 Ga

CAD Item #	US Item #	Description	Material	Width	#/Bag	Weight
C.T.O.	FG158TBH (PS)	1 5/8" Tension Band - Heavy	PS	1 3/8"	125	0.30 lbs
C.T.O.	FG178TBH (PS)	1 7/8" Tension Band - Heavy	PS	1 3/8"	125	0.40 lbs
C.T.O.	FG238TBH (PS)	2 3/8" Tension Band - Heavy	PS	1 5/8"	125	0.40 lbs
C.T.O.	FG278TBH (PS)	2 7/8" Tension Band - Heavy	PS	1 5/8"	125	0.50 lbs
C.T.O.	FG158TBH (BL)	1 5/8" Tension Band - Heavy	BL	1 7/8"	125	0.30 lbs
C.T.O.	FG178TBH (BL)	1 7/8" Tension Band - Heavy	BL	1 7/8"	125	0.40 lbs
C.T.O.	FG238TBH (BL)	2 3/8" Tension Band - Heavy	BL	2 3/8"	125	0.40 lbs
C.T.O.	FG278TBH (BL)	2 7/8" Tension Band - Heavy	BL	2 3/8"	125	0.50 lbs
C.T.O.	FG400TBH	4" Tension Band - Heavy	PS	2 7/8"	100	0.60 lbs
C.T.O.	FG658TBH	6 5/8" Tension Band - Heavy	PS	2 7/8"	50	0.90 lbs
C.T.O.	FG858TBH	8 5/8" Tension Band - Heavy	PS	3 1/2"	50	1.10 lbs

## Brace Bands - 12 Ga

CAD Item #	US Item #	Description	Material	Width	#/Bag	Weight
04020-PS	FG138BBR	1 3/8" Brace Band	PS	1 3/8"	250	0.10 lbs
04020-BL	FBK138BBR	1 3/8" Brace Band	BL	1 3/8"	250, 50	0.10 lbs
04021-PS	FG158BBR	1 5/8" Brace Band	PS	1 5/8"	250	0.20 lbs
04021-BL	FBK158BBR	1 5/8" Brace Band	BL	1 5/8"	250, 50	0.2 lbs
04022-PS	FG178BBR	1 7/8" Brace Band	PS	1 7/8"	250	0.2 lbs
04022-BL	FBK178BBR	1 7/8" Brace Band	BL	1 7/8"	250, 50	0.2 lbs
04023-PS	FG238BBR	2 3/8" Brace Band	PS	2 3/8"	250	0.2 lbs
04023-BL	FBK238BBR	2 3/8" Brace Band	BL	2 3/8"	250	0.2 lbs
04024-PS	FG278BBR	2 7/8" Brace Band	PS	2 7/8"	100	0.3 lbs
04024-BL	FBK278BBR	2 7/8" Brace Band	BL	2 7/8"	100, 50	0.3 lbs
04025-PS	FG312BBR	3 1/2" Brace Band	PS	3 1/2"	100	0.4 lbs
04025-BL	FG312BBR	3 1/2" Brace Band	BL	3 1/2"	100	0.4 lbs
C.T.O.	FG400BBR	4" Brace Band	PS	4"	100	0.4 lbs
C.T.O.	FBK400BBR	4" Brace Band	BL	4"	50	0.4 lbs
04026-PS	FG412BBR	4 1/2" Brace Band	PS	4 1/2"	100	0.4 lbs
04027-PS	C.T.O.	6 5/8" Brace Band	PS	6 5/8"	50	0.7 lbs



## Heavy Brace Bands - 11 Ga

CAD Item #	US Item #	Description	Material	Width	#/Bag	Weight
C.T.O.	FG158BBH	1 5/8" Brace Band - Heavy	PS	1 5/8"	125	0.3 lbs
C.T.O.	FG178BBH	1 7/8" Brace Band - Heavy	PS	1 7/8"	125	0.3 lbs
C.T.O.	FG238BBH	2 3/8" Brace Band - Heavy	PS	2 3/8"	125	0.4 lbs
C.T.O.	FG278BBH	2 7/8" Brace Band - Heavy	PS	2 7/8"	125	0.4 lbs
C.T.O.	FG400BBH	4" Brace Band - Heavy	PS	4"	100	0.6 lbs
C.T.O.	FG658BBH	6 5/8" Brace Band - Heavy	PS	6 5/8"	50	0.95 lbs
C.T.O.	FG858BBH	8 5/8" Brace Band - Heavy	PS	8 5/8"	50	1.22 lbs

## 2-Way Brace Bands - 12 Ga

CAD Item #	US Item #	Description	Material	Width	#/Bag	Weight
C.T.O.	FG17818BBTW	1 7/8" 2-Way Brace Band 180°	PS	1 7/8"	100	0.20 lbs
C.T.O.	FG23818BBTW	2 3/8" 2-Way Brace Band 180°	PS	2 3/8"	100	0.30 lbs
C.T.O.	FG27818BBTW	2 7/8" 2-Way Brace Band 180°	PS	2 7/8"	100	0.30 lbs
C.T.O.	FG40018BBTW	4" 2-Way Brace Band 180°	PS	4"	100	0.30 lbs



## Square Tension Bands - 13 Ga

CAD Item #	US Item #	Description	Material	Width	#/Bag	Weight
04710-WW	FG112SQTB	1 1/2" Square Tension Band	PS	1 1/2"	50	0.20 lbs
04712-WW	FG200SQTB	2" Square Tension Band	PS	2"	50	0.28 lbs
04714-WW	FG212SQTB	2 1/2" Square Tension Band	PS	2 1/2"	50	0.33 lbs
04716-WW	FG300SQTB	3" Square Tension Band	PS	3"	50	0.38 lbs
04720-WW	FG400SQTB	4" Square Tension Band	PS	4"	25	0.48 lbs
04722-WW	FG600SQTB	6" Square Tension Band	PS	6"	25	0.65 lbs



## Square Brace Bands - 13 Ga

CAD Item #	US Item #	Description	Material	Width	#/Bag	Weight
04740-WW	FG112SQBB	1 1/2" Square Brace Band	PS	1 1/2"	50	0.24 lbs
04742-WW	FG200SQBB	2" Square Brace Band	PS	2"	50	0.30 lbs
04744-WW	FG212SQBB	2 1/2" Square Brace Band	PS	2 1/2"	50	0.36 lbs
04746-WW	FG300SQBB	3" Square Brace Band	PS	3"	50	0.41 lbs
04750-WW	FG400SQBB	4" Square Brace Band	PS	4"	25	0.50 lbs
04752-WW	FG600SQBB	6" Square Brace Band	PS	6"	25	0.65 lbs



## Dome Caps - 13 Ga

CAD Item #	US Item #	Description	Material	Width	#/Bag	Weight
C.T.O.	FG138CPDC	1 3/8" Cap - Die Cast	DC	1 3/8"	350	0.06 lbs
C.T.O.	FG158CPDC	1 5/8" Cap - Die Cast	DC	1 5/8"	350	0.09 lbs
C.T.O.	FG178CPDC	1 7/8" Cap - Die Cast	DC	1 7/8"	250	0.10 lbs
C.T.O.	FG238CPDC	2 3/8" Cap - Die Cast	DC	2 3/8"	150	0.14 lbs
04030-WW	FG138CPPS	1 3/8" Cap - Pressed Steel	PS	1 3/8"	250, 200	0.13 lbs
04031-WW	FG158CPPS	1 5/8" Cap - Pressed Steel	PS	1 5/8"	350, 100	0.17 lbs
04032-WW	FG178CPPS	1 7/8" Cap - Pressed Steel	PS	1 7/8"	200, 100	0.23 lbs
04033-WW	FG238CPPS	2 3/8" Cap - Pressed Steel	PS	2 3/8"	125, 50	0.34 lbs
04034-WW	FG278CPPS	2 7/8" Cap - Pressed Steel	PS	2 7/8"	100, 50	0.48 lbs
04035-WW	FG312CPPS	3 1/2" Cap - Pressed Steel	PS	3 1/2"	50, 25	0.64 lbs
C.T.O.	FG400CPPS	4" Cap - Pressed Steel	PS	4"	25	0.80 lbs
04036-WW	FG412CPPS	4 1/2" Cap - Pressed Steel	PS	4 1/2"	50, 25	0.96 lbs
04037-WW	FG658CPPS	6 5/8" Cap - Pressed Steel	PS	6 5/8"	25, 10	3.50 lbs
C.T.O.	FG858CPPS	8 5/8" Cap - Pressed Steel	PS	8 5/8"	8	4.00 lbs
C.T.O.	FG238CPSD	2 3/8" Cap - Pressed Steel - Domestic	PS	2 3/8"	100	0.35 lbs
C.T.O.	FG278CPSD	2 7/8" Cap - Pressed Steel - Domestic	PS	2 7/8"	50	0.48 lbs
C.T.O.	FG400CPSD	4" Cap - Pressed Steel - Domestic	PS	4"	25	0.80 lbs
C.T.O.	FG658CPSD	6 5/8" Cap - Pressed Steel - Domestic	PS	6 5/8"	10	3.50 lbs
C.T.O.	FG858CPGI	8 5/8" Cap - Galvanized Iron	GI	8 5/8"	6	7.39 lbs
C.T.O.	FBK138CPDC	1 3/8" Cap - Die Cast (Black)	BL	1 3/8"	100	0.06 lbs
C.T.O.	FBK158CPDC	1 5/8" Cap - Die Cast (Black)	BL	1 5/8"	100	0.09 lbs
C.T.O.	FBK178CPDC	1 7/8" Cap - Die Cast (Black)	BL	1 7/8"	100	0.10 lbs
C.T.O.	FBK238CPDC	2 3/8" Cap - Die Cast (Black)	BL	2 3/8"	100	0.14 lbs
C.T.O.	FBK138CPPS	1 3/8" Cap - Pressed Steel (Black)	BL	1 3/8"	25	0.13 lbs
C.T.O.	FBK158CPPS	1 5/8" Cap - Pressed Steel (Black)	BL	1 5/8"	25	0.17 lbs
C.T.O.	FBK178CPPS	1 7/8" Cap - Pressed Steel (Black)	BL	1 7/8"	25	0.23 lbs
C.T.O.	FBK238CPPS	2 3/8" Cap - Pressed Steel (Black)	BL	2 3/8"	25	0.34 lbs
C.T.O.	FBK278CPPS	2 7/8" Cap - Pressed Steel (Black)	BL	2 7/8"	25	0.48 lbs
C.T.O.	FBK400CPPS	4" Cap - Pressed Steel (Black)	BL	4"	25	0.80 lbs
C.T.O.	FBK658CPPS	6 5/8" Cap - Pressed Steel (Black)	BL	6 5/8"	10	1.00 lbs



## Square Caps - 13 Ga

CAD Item #	US Item #	Description	Material	Width	#/Bag	Weight
04762-WW	C.T.O.	2" Square Cap	DC	2"	250	0.12 lbs
04764-WW	C.T.O.	2 1/2" Square Cap	DC	2 1/2"	200	0.14 lbs
04766-WW	FG300CPSQ	3" Square Cap - Pressed Steel	PS	3"	125	0.25 lbs
04770-WW	FG400CPSQ	4" Square Cap - Pressed Steel	PS	4"	100	0.28 lbs
04772-WW	FG600CPSQ	6" Square Cap - Pressed Steel	PS	6"	50	0.62 lbs



## Versai Pressed Square Dome Caps

CAD Item #	US Item #	Description	Material	Width	Weight
C.T.O.	ORF112DCAP	1 1/2" x 1 1/2" Black Post Cap	BL	1 1/2"	0.05 lbs
16540BD	ORF200DCAP	2" x 2" Black Post Cap	BL	2"	0.13 lbs
16541BD	ORF212DCAP	2 1/2" x 2 1/2" Black Post Cap	BL	2 1/2"	0.13 lbs
C.T.O.	ORF300DCAP	3" x 3" Black Post Cap	BL	3"	0.20 lbs
C.T.O.	OBK400CAP	4" x 4" Black Post Cap	BL	4"	0.33 lbs
C.T.O.	OBK600CAP	6" x 6" Black Post Cap	BL	6"	0.45 lbs
C.T.O.	ORF5858PLUG	5/8" x 5/8" Black Plastic Plug Cap		5/8"	0.01 lbs
C.T.O.	ORF100PLUG	1" x 1" Black Plastic Plug Cap		1"	0.02 lbs
C.T.O.	ORF112PLUG	1-1/2" x 1-1/2" Black Plastic Plug Cap		1 1/2"	0.04 lbs
C.T.O.	ORF200PLUG	2" x 2" Black Plastic Plug Cap		2"	0.10 lbs



## Truss Rods

CAD Item #	US Item #	Description	Material	Height	#/Bag	Weight
C.T.O.	FG51101TROD	10 1/2' Truss Rod	GI	126"	25	2.90 lbs
04180-PS	FG5112TROD	12' Truss Rod (3/8")	GI	144"	25	4.50 lbs
C.T.O.	FBK5112TROD	12' Truss Rod (Black)	BL		25	3.30 lbs

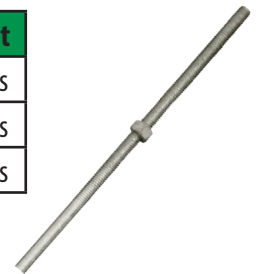

## Truss Rods Tighteners

CAD Item #	US Item #	Description	Material	Height	#/Bag	Weight
04184-PS	C.T.O.	Truss Rod Tightener	GI		100	0.70 lbs
C.T.O.	FGTIGHTENS	Truss Rod Tightener - Residential	GI		50	0.24 lbs
C.T.O.	FBKTIGHTNH	Truss Rod Tightener - Indust. Black	BL		25	0.68 lbs
C.T.O.	FGTIGHTENH	Truss Rod Tightener - Industrial	GI		50	0.68 lbs
C.T.O.	FG515STRE	5/16" x 5" Stretch Bolt	GI	5"	500	0.17 lbs



## Tension Bars

CAD Item #	US Item #	Description	Material	Height	Thickness	Width	#/Bag	Weight
04210-WW	FG5834TBAR	34" Tension Bar (3/16" x 5/8")	PS	34"	3/16"	5/8"	25	0.90 lbs
C.T.O.	FBK5834TBAR	34" Tension Bar (3/16" x 5/8")	BL	34"	3/16"	5/8"	26	0.90 lbs
C.T.O.	FG5840TBAR	40" Tension Bar (3/16" x 5/8")	PS	40"	3/16"	5/8"	25	1.30 lbs
C.T.O.	FBK5840TBAR	40" Tension Bar (3/16" x 5/8")	BL	40"	3/16"	5/8"	26	1.30 lbs
04212-WW	FBK5846TBAR	46" Tension Bar (3/16" x 5/8")	PS	46"	3/16"	5/8"	25	1.30 lbs
04212-WW	FG5846TBAR	46" Tension Bar (3/16" x 5/8")	BL	46"	3/16"	5/8"	25	1.30 lbs
04213-WW	FG5858TBAR	58" Tension Bar (3/16" x 5/8")	PS	58"	3/16"	5/8"	25	1.60 lbs
04213-WW	FBK5858TBAR	58" Tension Bar (3/16" x 5/8")	BL	58"	3/16"	5/8"	25	1.60 lbs
04214-WW	FG5870TBAR	70" Tension Bar (3/16" x 5/8")	PS	70"	3/16"	5/8"	25	2.00 lbs
04214-WW	FBK5870TBAR	70" Tension Bar (3/16" x 5/8")	BL	70"	3/16"	5/8"	25	2.00 lbs
04215-WW	C.T.O.	82" Tension Bar (3/16" x 5/8")	PS	82"	3/16"	5/8"	25	2.30 lbs
04216-WW	C.T.O.	94" Tension Bar (3/16" x 5/8")	PS	94"	3/16"	5/8"	25	2.70 lbs
04218-WW	C.T.O.	118" Tension Bar (3/16" x 5/8")	PS	118"	3/16"	5/8"	25	3.40 lbs
04221-WW	C.T.O.	216" Tension Bar (3/16" x 5/8")	PS	216"	3/16"	5/8"	25	6.20 lbs
C.T.O.	FG3440TBAR	40" Tension Bar (3/16" x 3/4")	PS	40"	3/16"	3/4"	25	1.30 lbs
04232-WW	FG3446TBAR	46" Tension Bar (3/16" x 3/4")	PS	46"	3/16"	3/4"	25	1.60 lbs
04233-WW	FG3458TBAR	58" Tension Bar (3/16" x 3/4")	PS	58"	3/16"	3/4"	25	1.90 lbs
04234-WW	FG3470TBAR	70" Tension Bar (3/16" x 3/4")	PS	70"	3/16"	3/4"	25	2.40 lbs
04235-WW	FG3482TBAR	82" Tension Bar (3/16" x 3/4")	PS	82"	3/16"	3/4"	25	2.80 lbs
04236-PS	FG3494TBAR	94" Tension Bar (3/16" x 3/4")	PS	94"	3/16"	3/4"	25	3.20 lbs
04236-BL	FG3494TBAR	94" Tension Bar (3/16" x 3/4")	BL	94"	3/16"	3/4"	25	3.20 lbs
04237-PS	FG34118TBAR	118" Tension Bar (3/16" x 3/4")	PS	118"	3/16"	3/4"	25	4.10 lbs
04238-PS	FG34142TBAR	142" Tension Bar (3/16" x 3/4")	PS	142"	3/16"	3/4"	25	4.80 lbs
04239-PS	C.T.O.	216" Tension Bar (3/16" x 3/4")	PS	216"	3/16"	3/4"	25	7.30 lbs



## Pipe Straps/Supports

CAD Item #	US Item #	Description	Width	#/Bag	Weight
C.T.O.	FG158STRAP	1 5/8" Pipe Strap	1 5/8"	100	0.50 lbs
C.T.O.	FG178STRAP	1 7/8" Pipe Strap	1 7/8"	100	0.55 lbs
C.T.O.	FG238STRAP	2 3/8" Pipe Support Strap	2 3/8"	100	2.55 lbs
C.T.O.	FG278STRAP	2 7/8" Pipe Support Strap	2 7/8"	100	2.69 lbs



## Carriage Bolts (w/nut)

CAD Item #	US Item #	Description	Material	Type	Width	Length	#/Bag	Weight
06070-PS	FG3200BOLT	3/8" x 2" Carriage Bolt	PS	Bolt	3/8"	2"	100	0.01 lbs
06072-PS	FG3214BOLT	3/8" x 2 1/4" Carriage Bolt	PS	Bolt	3/8"	2 1/4"	100	0.01 lbs
06072-BL	FBK3214BOLT	3/8" x 2 1/4" Carriage Bolt	BL	Bolt	3/8"	2 1/4"	100	0.01 lbs
06074-PS	FG3212BOLT	3/8" x 2 1/2" Carriage Bolt	PS	Bolt	3/8"	2 1/2"	100	0.01 lbs
06078-PS	FG3300BOLT	3/8" x 3" Carriage Bolt	PS	Bolt	3/8"	3"	100	0.01 lbs
06078-BL	FBK3300BOLT	3/8" x 3" Carriage Bolt	BL	Bolt	3/8"	3"	100	0.01 lbs
06082-PS	FG3312BOLT	3/8" x 3 1/2" Carriage Bolt	PS	Bolt	3/8"	3 1/2"	100	0.01 lbs
06082-BL	FBK3312BOLT	3/8" x 3 1/2" Carriage Bolt	BL	Bolt	3/8"	3 1/2"	100	0.01 lbs
06086-PS	FG3400BOLT	3/8" x 4" Carriage Bolt	PS	Bolt	3/8"	4"	100	0.01 lbs
06090-PS	FG5114BOLT	5/16" x 1 1/4" Carriage Bolt	PS	Bolt	5/16"	1 1/4"	100	0.01 lbs
06090-BL	FG5114BOLT	5/16" x 1 1/4" Carriage Bolt	BL	Bolt	5/16"	1 1/4"	100	0.01 lbs
06092-WW	C.T.O.	5/16" x 1 1/2" Carriage Bolt	PS	Bolt	5/16"	1 1/2"	100	0.01 lbs
06098-WW	FG5212BOLT	5/16" x 2 1/2" Carriage Bolt	PS	Bolt	5/16"	2 1/2"	100	0.01 lbs
06099-WW	FG5212BOLT	5/8" x 2 1/2" Carriage Bolt	PS	Bolt	5/8"	2 1/2"	100	0.01 lbs
C.T.O.	FBK5114BOLT	*5/16" x 1 1/4" Carriage Bolt (Black)	BL	Bolt	5/16"	1 1/4"	2000	0.04 lbs
C.T.O.	FBK516NUTS	5/16"-18 Finished Hex Nut (Black)	BL	Hex Nut	5/16"	5/16"	2000	0.01 lbs
C.T.O.	FBK380NUTS	3/8"-16 Finished Hex Nut (Black)	BL	Hex Nut	3/8"	3/8"	1000	0.02 lbs

## Anchor Bolts



CAD Item #	US Item #	Description	Material	Type	Width	Length	#/Bag	Weight
06176-PS	C.T.O.	1/2" x 2 3/4" Anchor Bolt	PS	Bolt	1/2"	2 3/4"	25	0.50 lbs
06178-PS	C.T.O.	1/2" x 3 3/4" Anchor Bolt	PS	Bolt	1/2"	3 3/4"	25	0.50 lbs

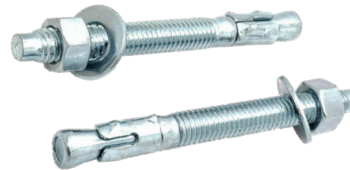

## U-Bolts

CAD Item #	US Item #	Description	Material	Width	#/Bag	Weight
C.T.O.	FG238UBLT	1/2" x 2 3/8" U-Bolt	PS	2 3/8"	1000	0.52 lbs
C.T.O.	FG278UBLT	1/2" x 2 7/8" U-Bolt	PS	2 7/8"	1000	0.60 lbs
C.T.O.	FG400UBLT	1/2" x 4" U-Bolt	PS	4"	1000	0.90 lbs
C.T.O.	FG412UBLT	1/2" x 4 1/2" U-Bolt	PS	4 1/2"	1000	0.95 lbs
C.T.O.	FG658UBLT	5/8" x 6 5/8" U-Bolt	PS	6 5/8"	1000	1.40 lbs



## Fence Staples

CAD Item #	US Item #	Description	Bin Size	Length	#/Bag	Weight
18562	C.T.O.	7/8" Galv. Plastic Pail Fence Staples	Small	7/8"	2080	8 lbs
18564	C.T.O.	1 1/4" Galv. Plastic Pail Fence Staples (Barbed)	Small	1 1/4"	752	8 lbs
18566	C.T.O.	1 1/2" Galv. Plastic Pail Fence Staples (Barbed)	Small	1 1/2"	560	8 lbs
18568	C.T.O.	1 3/4" Galv. Plastic Pail Fence Staples (Barbed)	Small	1 3/4"	440	8 lbs
18570	C.T.O.	2" Galv. Plastic Pail Fence Staples (Barbed)	Small	2"	264	8 lbs
18574	C.T.O.	1 1/4" Galv. Plastic Pail Fence Staples (Barbed)	Medium	1 1/4"	2820	30 lbs
18576	C.T.O.	1 1/2" Galv. Plastic Pail Fence Staples (Barbed)	Medium	1 1/2"	2100	30 lbs
18578	C.T.O.	1 3/4" Galv. Plastic Pail Fence Staples (Barbed)	Medium	1 3/4"	1650	30 lbs
18580	C.T.O.	2" Galv. Plastic Pail Fence Staples (Barbed)	Medium	2"	990	30 lbs
18584	C.T.O.	7/8" Galv. Plastic Pail Fence Staples	Large	7/8"	13000	50 lbs
18586	C.T.O.	1 1/4" Galv. Plastic Pail Fence Staples (Barbed)	Large	1 1/4"	4700	50 lbs
18588	C.T.O.	1 1/2" Galv. Plastic Pail Fence Staples (Barbed)	Large	1 1/2"	3500	50 lbs
18590	C.T.O.	1 3/4" Galv. Plastic Pail Fence Staples (Barbed)	Large	1 3/4"	2750	50 lbs
18592	C.T.O.	2" Galv. Plastic Pail Fence Staples (Barbed)	Large	2"	1650	50 lbs



## Base Plates

CAD Item #	US Item #	Description	Material	Type	Width	Length	#/Box	Weight
06122-PS	FG3658FIAT	3" x 6" x 1/4" Base Plate	PS	Plate	3"	6"	25	1.15 lbs
06130-PS	FG4458FIAT	4" x 4" x 1/4" Base Plate	PS	Plate	4"	4"	25	1.16 lbs
06132-PS	C.T.O.	4" x 6" x 1/4" Base Plate	PS	Plate	4"	6"	25	1.50 lbs
06134-PS	FG6658FIAT	6" x 6" x 1/4" Base Plate	PS	Plate	6"	6"	25	2.30 lbs
06136-PS	FG8858FIAT	8" x 8" x 1/4" Base Plate	PS	Plate	8"	8"	10	4.25 lbs
06150-PS	C.T.O.	4" x 4" x 1/2" Base Plate	PS	Plate	4"	4"	20	4.60 lbs
06152-PS	C.T.O.	6" x 6" x 1/2" Base Plate	PS	Plate	6"	6"	10	4.60 lbs
06154-PS	C.T.O.	8" x 8" x 1/2" Base Plate	PS	Plate	8"	8"	10	5.30 lbs

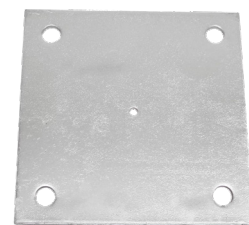

## Barbed Wire

CAD Item #	US Item #	Description	Gauge	Length (ft)	#/Pallet	Weight
06200-GA	BW1548WI	15 1/2 Ga. Class 3 High Tensile Barbed Wire	15.5	1320	27	37 lbs
06202-GA	BW12123BASTM	12 1/2 Ga. Barbless Barbed Wire	12.5	1320	48	70 lbs
06204-GA	N/A	12 1/2 Ga. Canadian Standard Barbed Wire	12.5	1320	27	80 lbs
06206-GA	BW1243BWD	12 1/2 Ga. Class 3 Barbed Wire	12.5	1320	27	85 lbs
C.T.O.	B1245COM	12 1/2 Ga. 4 point 5" Barbed Wire - Commercial	12.5	1320	27	76 lbs
06206-BL	C.T.O.	12 1/2 Ga. Class 3 Barbed Wire- Black	12.5	1320	27	82 lbs
06203-GA	C.T.O.	12 1/2 Ga. Canadian Standard Barbed Wire - Half Roll	12.5	660	84	40 lbs
C.T.O.	BWBK4PTBW	4 Point Vinyl Coated Barb Wire (Black)				85 lbs
C.T.O.	BWBN4PTBW	4 Point Vinyl Coated Barb Wire (Brown)				85 lbs
C.T.O.	BWGN4PTBW	4 Point Vinyl Coated Barb Wire (Green)				85 lbs
06204-IMP	C.T.O.	12 1/2 Ga. Canadian Standard Barbed Wire IMPORT	12.5	1320	27	80 lbs
06206-IMP	C.T.O.	12 1/2 Ga. Class 3 Barbed Wire IMPORT	12.5	1320	27	81 lbs



## Barbed Tape/Razor Wire

CAD Item #	US Item #	Description	Length (ft)	#/Pallet	Weight
C.T.O.	BW018RGLR	18" dia Regular Security Barbed Tape (Single Coil)		5	11.00 lbs
06210-PS	C.T.O.	18" Diameter Razor Ribbon - 50' /Roll	50		40 lbs



## Bottom Wire

CAD Item #	US Item #	Description	Material	Gauge	Weight
06050-WW	C.T.O.	11 Ga. Bottom Wire	GA	11	0.03 lbs/ft
06052-WW	C.T.O.	9 Ga. Bottom Wire	GA	9	0.03 lbs/ft
06052-WW	C.T.O.	9 Ga. Bottom Wire	BL	9	0.03 lbs/ft
06056-WW	C.T.O.	6 Ga. Bottom Wire	GA	6	0.10 lbs/ft
06056-WW	C.T.O.	6 Ga. Bottom Wire	BL	6	0.10 lbs/ft



## Merchant Coils/Tension Wire

CAD Item #	US Item #	Description	Gauge	Length (ft)	#/Pallet	Weight
18496	TW16010GA	16 Ga. Galv. Merchant Coils	16	973		10 lbs
18498	TW14010GA	14 Ga. Galv. Merchant Coils	14	580		10 lbs
18502	TW12010GA	12 Ga. Galv. Merchant Coils	12	375		10 lbs
18506	AF0910MCGA	9 Ga. Galv. Merchant Coils (.134)	9	180		10 lbs
18500	TW14050GA	14 Ga. Galv. Merchant Coils	14	2900		50 lbs
18504	TW12050GA	12 Ga. Galv. Merchant Coils	12	1875		50 lbs
18508	TW09050GA	9 Ga. Galv. Merchant Coils (.134)	9	900		50 lbs
18513	C.T.O.	14 Ga. Black Annealed Merchant Coils	14	650		10 lbs
18512	C.T.O.	12 Ga. Black Annealed Merchant Coils	12	330		10 lbs
18516	C.T.O.	9 Ga. Black Annealed Merchant Coils	9	170		10 lbs
18510	C.T.O.	12 Ga. Black Annealed Merchant Coils	12	1650		50 lbs
18518	C.T.O.	9 Ga. Black Annealed Merchant Coils	9	850		50 lbs
18530	C.T.O.	12.5 Ga. Galv. Hi-Tensile (Wood Spool)	12.5	3800		100 lbs
C.T.O.	TW16050GA	16 ga Tension Wire - 50 lbs	16	5500		50.00 lbs
C.T.O.	TW14050GA	14 ga Tension Wire - 50 lbs	14	2929		50.00 lbs
C.T.O.	TW12050GA	12 ga Tension Wire - 50 lbs	12	1684		50.00 lbs
C.T.O.	TW09050GA	9 ga Tension Wire - 50 lbs	9	850		50.00 lbs
C.T.O.	TW7500COIL	7 ga Coil Spring 1.2 oz -500 ft	7	500		42.50 lbs
C.T.O.	TW09100GA	9 ga Tension Wire - 100 lbs	9	1700		100.00 lbs
C.T.O.	TW71000COIL	7 ga Coil Spring 1.2 oz -1000ft	7	1000		85.00 lbs
C.T.O.	TW09025BK	9 ga Tension Wire - 25 lbs (Black)	9		10	25.00 lbs
C.T.O.	TW09025BN	9 ga Tension Wire - 25 lbs (Brown)	9		10	25.00 lbs
C.T.O.	TW09025GN	9 ga Tension Wire - 25 lbs (Green)	9		10	25.00 lbs
C.T.O.	TW09050BK	9 ga Tension Wire - 50 lbs (Black)	9		10	50.00 lbs
C.T.O.	TBK700COIL	7 ga Coil Spring 1.2 oz - 1000ft (Black)	7	1000	10	84.00 lbs
C.T.O.	TBK750COIL	7 ga Coil Spring 1.2 oz - 500ft (Black)	7	500	10	42.00 lbs
C.T.O.	TBN750COIL	7 ga Coil Spring 1.2 oz - 500ft (Brown)	7	500	10	42.00 lbs
C.T.O.	TGN750COIL	7 ga Coil Spring 1.2 oz - 500ft (Green)	7	500	10	42.00 lbs



## Electric Fence Wire

CAD Item #	US Item #	Description	Gauge	Length (ft)	Weight
18533	C.T.O.	Electric Fence Wire 17 Ga. (4 x 1/4 mile spools per Box)	17	5280	41 lbs
18534	C.T.O.	Electric Fence Wire 14 Ga. (2 x 1/4 mile spools per Box)	14	2640	45 lbs
18535	C.T.O.	Electric Fence Wire 16 Ga. (4 x 1/4 mile spools per Box)	16	5280	57 lbs



## Rail Ends

CAD Item #	US Item #	Description	Material	Length	#/Bag	Weight
C.T.O.	FG138REDC	1 3/8" Rail End - Die Cast	DC	1 3/8"	500	0.13 lbs
C.T.O.	FG158REDC	1 5/8" Rail End - Die Cast	DC	1 5/8"	250	0.18 lbs
04050-WW	FG1381REPS	1 3/8" Rail End (One Hole) - Pressed Steel	PS	1 3/8"	100	0.26 lbs
04051-WW	FG1581REPS	1 5/8" Rail End (One Hole) - Pressed Steel	PS	1 5/8"	100	0.31 lbs
04053-WW	FG1781REPS	1 7/8" Rail End (One Hole) - Pressed Steel	PS	1 7/8"	100, 50	0.33 lbs
04054-WW	FG2381REPS	2 3/8" Rail End (One Hole) - Pressed Steel	PS	2 3/8"	100, 50	0.56 lbs
04052-WW	FG1582REPS	1 5/8" Rail End (Two Hole) - Pressed Steel	PS	1 5/8"	100	0.45 lbs
C.T.O.	FG1782REPS	1 7/8" Rail End (Two Hole) - Pressed Steel	PS	1 7/8"	50	0.50 lbs
C.T.O.	FG1581REPSD	1 5/8" Rail End (One Hole) - P.S. Domestic	PS	1 5/8"	100	0.31 lbs
C.T.O.	FG1781REPSD	1 7/8" Rail End (One Hole) - P.S. Domestic	PS	1 7/8"	50	0.33 lbs
C.T.O.	FG2381REPSD	2 3/8" Rail End (One Hole) - P.S. Domestic	PS	2 3/8"	50	0.56 lbs
C.T.O.	FG1582REPSD	1 5/8" Rail End (Two Hole) - P.S. Domestic	PS	1 5/8"	100	0.45 lbs
C.T.O.	FG1583REPS	1 5/8" Rail End (Combo) - Pressed Steel	PS	1 5/8"	100	0.31 lbs
C.T.O.	FBK138REDC	1 3/8" Rail End - Die Cast (Black)	BL	1 3/8"	50	0.13 lbs
C.T.O.	FBK158REDC	1 5/8" Rail End - Die Cast (Black)	BL	1 5/8"	50	0.18 lbs
C.T.O.	FBK1381REPS	1 3/8" Rail End (One Hole) - Pressed Steel (Black)	BL	1 3/8"	50	0.26 lbs
C.T.O.	FBK1581REPS	1 5/8" Rail End (One Hole) - Pressed Steel (Black)	BL	1 5/8"	50	0.31 lbs
C.T.O.	FBK1582REPS	1 5/8" Rail End (Two Hole) - Pressed Steel (Black)	BL	1 5/8"	50	0.45 lbs



## Eye Tops

CAD Item #	US Item #	Description	Material	Length	#/Bag	Weight
C.T.O.	FG1513ETDC	1 5/8" x 1 3/8" Eye Top - Die Cast	DC	1 5/8"	200	0.14 lbs
C.T.O.	FG1713ETDC	1 7/8" x 1 3/8" Eye Top - Die Cast	DC	1 7/8"	100	0.19 lbs
C.T.O.	FG1715ETDC	1 7/8" x 1 5/8" Eye Top - Die Cast	DC	1 7/8"	100	0.21 lbs
04040-XX	FG1513ETPSR	1 5/8" x 1 3/8" Eye Top - Residential Pressed Steel	PS	1 5/8"	100, 50	0.20 lbs
04042-XX	FG1713ETPSR	1 7/8" x 1 3/8" Eye Top - Residential Pressed Steel	PS	1 7/8"	100, 50	0.25 lbs
04043-XX	FG1715ETPSR	1 7/8" x 1 5/8" Eye Top - Residential Pressed Steel	PS	1 7/8"	100, 50	0.38 lbs
04041-PS	FG1515ETPSC	1 5/8" x 1 5/8" Eye Top - Commercial Pressed Steel	PS	1 5/8"	100, 50	0.52 lbs
C.T.O.	FG1715ETPSC	1 7/8" x 1 5/8" Eye Top - Commercial Pressed Steel	PS	1 7/8"	50	0.56 lbs
04044-XX	FG2315ETPSC	2 3/8" x 1 5/8" Eye Top - Commercial Pressed Steel	PS	2 3/8"	50	0.75 lbs
04045-PS	FG2715ETPSC	2 7/8" x 1 5/8" Eye Top - Commercial Pressed Steel	PS	2 7/8"	50	0.92 lbs
C.T.O.	FG4015ETPSC	4" x 1 5/8" Eye Top - Commercial Pressed Steel	PS	4"	25	1.51 lbs
C.T.O.	FG1715ETPSD	1 7/8" x 1 5/8" Eye Top - Pressed Steel - Domestic	PS	1 7/8"	50	0.56 lbs
C.T.O.	FG2315ETPSD	2 3/8" x 1 5/8" Eye Top - Pressed Steel - Domestic	PS	2 3/8"	50	0.75 lbs
C.T.O.	FG2715ETPSD	2 7/8" x 1 5/8" Eye Top - Pressed Steel - Domestic	PS	2 7/8"	50	0.92 lbs
C.T.O.	FBK1513ETDC	1 5/8" x 1 3/8" Eye Top - Die Cast (Black)	BL	1 5/8"	50	0.14 lbs
C.T.O.	FBK1713ETDC	1 7/8" x 1 3/8" Eye Top - Die Cast (Black)	BL	1 7/8"	50	0.19 lbs
C.T.O.	FBK1715ETDC	1 7/8" x 1 5/8" Eye Top - Die Cast (Black)	BL	1 7/8"	50	0.21 lbs
C.T.O.	FBK1513ETPSR	1 5/8" x 1 3/8" Eye Top - Residential Pressed Steel (Black)	BL	1 5/8"	50	0.20 lbs
C.T.O.	FBK1713ETPSR	1 7/8" x 1 3/8" Eye Top - Residential Pressed Steel (Black)	BL	1 7/8"	50	0.25 lbs
C.T.O.	FBK1715ETPSC	1 7/8" x 1 5/8" Eye Top - Commercial Pressed Steel (Black)	BL	1 7/8"	50	0.56 lbs
C.T.O.	FBK2315ETPSC	2 3/8" x 1 5/8" Eye Top - Commercial Pressed Steel (Black)	BL	1 3/8"	50	0.75 lbs
C.T.O.	FBK2715ETPSC	2 7/8" x 1 5/8" Eye Top - Commercial Pressed Steel (Black)	BL	1 5/8"	50	0.75 lbs



## Sleeves

CAD Item #	US Item #	Description	Material	Length	#/Bag	Weight
04060-XX	FG1386SLEV	1 3/8" x 6" Sleeves	DC	1 3/8"	100	0.36 lbs
04061-XX	FG1586SLEV	1 5/8" x 6" Sleeves	DC	1 5/8"	50, 100	0.62 lbs
C.T.O.	FG1787SLEV	1 7/8" x 7" Sleeves	PS	1 7/8"	50	0.69 lbs
C.T.O.	FBK1386SLEV	1 3/8" x 6" Sleeve (Black)	PS	1 3/8"	25	0.39 lbs
C.T.O.	FBK1586SLEV	1 5/8" x 6" Sleeves (Black)	PS	1 5/8"	25	0.62 lbs



## Backstop Adapter

CAD Item #	US Item #	Description	#/Bag	Weight
C.T.O.	FGBACKSTOP	Backstop Adapter	12	3.25 lbs



## Weld-on Caps

CAD Item #	US Item #	Description	Material	Length	#/Bag	Weight
C.T.O.	FG138WELD	1 3/8" Weld-on Steel Cap	PS	1 3/8"	200	0.04 lbs
C.T.O.	FG158WELD	1 5/8" Weld-on Steel Cap	PS	1 5/8"	200	0.05 lbs
C.T.O.	FG178WELD	1 7/8" Weld-on Steel Cap	PS	1 7/8"	200	0.07 lbs
C.T.O.	FG238WELD	2 3/8" Weld-on Steel Cap	PS	2 3/8"	100	0.13 lbs
C.T.O.	FG278WELD	2 7/8" Weld-on Steel Cap	PS	2 7/8"	100	0.18 lbs
C.T.O.	FG400WELD	4" Weld-on Steel Cap	PS	4"	50	0.32 lbs
C.T.O.	FG178FLTWELD	1 7/8" Flat Weld-on Cap	PS	1 7/8"	200	0.07 lbs

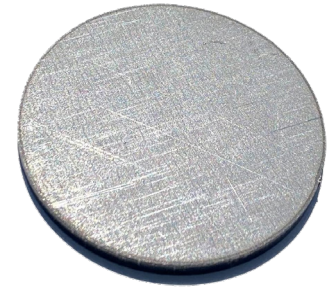

## Drive-In Plugs

CAD Item #	US Item #	Description	Material	Length	#/Bag	Weight
C.T.O.	FG138PLUG	1 3/8" Plug Cap - Cast Aluminum	AL	1 3/8"	100	0.06 lbs
C.T.O.	FG158PLUG	1 5/8" Plug Cap - Cast Aluminum	AL	1 5/8"	100	0.09 lbs
C.T.O.	FG178PLUG	1 7/8" Plug Cap - Cast Aluminum	AL	1 7/8"	100	0.11 lbs
C.T.O.	FG238PLUG	2 3/8" Plug Cap - Cast Aluminum	AL	2 3/8"	100	0.17 lbs
05754-MA	C.T.O.	1 3/8" Drive In Plug	MA	1 3/8"	200	0.20 lbs
05756-MA	C.T.O.	1 5/8" Drive In Plug	MA	1 5/8"	200	0.30 lbs
05758-MA	C.T.O.	1 7/8" Drive In Plug	MA	1 7/8"	200	0.40 lbs



## Post Plate

CAD Item #	US Item #	Description	#/Bag	Weight
C.T.O.	FGUNIPSTPL	Universal Post Plate	100	0.40 lbs
C.T.O.	FGDUALTOP	Dual Top Post Plate	100	0.45 lbs



## Barb Arms: 45°

CAD Item #	US Item #	Description	Material	Length	#/Bag	Weight
04311-PS	FG15150BAS	1 5/8" x 1 5/8" One Piece Barb Arm	PS	1 5/8"	25	1.65 lbs
04312-PS	FG17150BAS	1 7/8" x 1 5/8" One Piece Barb Arm	PS	1 7/8"	25	1.70 lbs
04313-PS	FG23150BAS	2 3/8" x 1 5/8" One Piece Barb Arm	PS	2 3/8"	25	1.90 lbs
C.T.O.	FG27150BAS	2 7/8" x 1 5/8" One Piece Barb Arm	PS	2 7/8"	25	2.05 lbs



## Barb Arms: 45° - Domestic 250#

CAD Item #	US Item #	Description	Material	Length	#/Bag	Weight
C.T.O.	FG17150BAD	1 7/8" x 1 5/8" One Piece Barb Arm	PS	1 5/8"	25	1.80 lbs
C.T.O.	FG23150BAD	2 3/8" x 1 5/8" One Piece Barb Arm	PS	1 7/8"	25	2.00 lbs
C.T.O.	FG27150BAD	2 7/8" x 1 5/8" One Piece Barb Arm	PS	2 3/8"	25	2.05 lbs



## Barb Arms - Vertical

CAD Item #	US Item #	Description	Material	Length	#/Bag	Weight
04311-PS	FG158VBAS	1 5/8" Vertical Barb Arm	PS	1 5/8"	25	1.40 lbs
04312-PS	FG178VBAS	1 7/8" Vertical Barb Arm	PS	1 7/8"	25	1.50 lbs
04313-PS	FG238VBAS	2 3/8" Vertical Barb Arm	PS	2 3/8"	25	1.70 lbs
C.T.O.	FG178VBAD	1 7/8" Vertical Barb Arm - Domestic	PS	1 7/8"	25	1.50 lbs
C.T.O.	FG238VBAD	2 3/8" Vertical Barb Arm - Domestic	PS	2 3/8"	25	1.90 lbs



## Universal Barb Arm - Steel

CAD Item #	US Item #	Description	Material	Length (ft)	#/Bag	Weight
C.T.O.	FGUNIBA	Universal Barb Arm - Steel	PS		25	3.00 lbs



## Barb Arms: "V" Type Line

CAD Item #	US Item #	Description	Material	Length	#/Bag	Weight
04321-PS	C.T.O.	1 7/8" x 1 5/8" V-Type Barb Arm	PS	1 7/8"	25	2.10 lbs
04322-PS	FG2315VOBAS	2 3/8" x 1 5/8" V-Type Barb Arm	PS	2 3/8"	25	3.00 lbs
04323-PS	FG2715VOBAS	2 7/8" x 1 5/8" V-Type Barb Arm	PS	2 7/8"	25	3.40 lbs
C.T.O.	FG2315VOBAD	2 3/8" x 1 5/8" V-Type Barb Arm - Domestic	PS	2 3/8"	25	3.00 lbs
C.T.O.	FG2715VOBAD	2 7/8" x 1 5/8" V-Type Barb Arm - Domestic	PS	2 7/8"	25	3.40 lbs

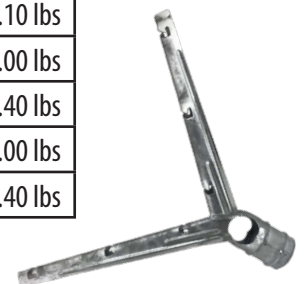

## Barb Wire Extension Arms

CAD Item #	US Item #	Description	Material	Type	#/Bag	Weight
04362-PS	FGSINGLSBA	Single (S Slot) Barb Wire Arm	PS	Single		0.85 lbs
04360-PS	FGNOTCHSBA	Notched (S Slot) Barb Wire Arm	PS	Notched	25, 50	0.85 lbs
C.T.O.	FGEXARMBKT	Holding Bracket	PS	Bracket	50	0.23 lbs



## Barb Bases

CAD Item #	US Item #	Description	Material	Length	#/Bag	Weight
C.T.O.	FG1715BWBPS	1 7/8" x 1 5/8" Barb Base - Pressed Steel	PS	1 7/8"	25, 50	0.69 lbs
04351-PS	FG2315BWBPS	2 3/8" x 1 5/8" Barb Base - Pressed Steel	PS	2 3/8"	25, 50	0.75 lbs
04352-PS	FG2715BWBPS	2 7/8" x 1 5/8" Barb Base - Pressed Steel	PS	2 7/8"	25	0.84 lbs



## Corner Arms - 45° & V Type

CAD Item #	US Item #	Description	Material	Length	#/Bag	Weight
04330-PS	FG238CAPS	2 3/8" Corner Barb Arm - Pressed Steel	PS	2 3/8"	25, 10	2.46 lbs
04331-PS	FG278CAPS	2 7/8" Corner Barb Arm - Pressed Steel	PS	2 7/8"	25, 10	2.65 lbs
04332-PS	C.T.O.	3 1/2" Corner Barb Arm - Pressed Steel	PS	3 1/2"	25	3.50 lbs
C.T.O.	FG400CAPS	4" Corner Barb Arm - Pressed Steel	PS	4"	5	2.89 lbs
C.T.O.	FG238CAGI	2 3/8" Corner Barb Arm - Galv. Iron	GI	2 3/8"	10	4.00 lbs
C.T.O.	FG278CAGI	2 7/8" Corner Barb Arm - Galv. Iron	GI	2 7/8"	10	4.20 lbs
C.T.O.	FG400CAGI	4" Corner Barb Arm - Galv. Iron	GI	4"	8	5.70 lbs
C.T.O.	FG238CAD	2 3/8" Corner Barb Arm - Pressed Steel - U.S. Domestic	PS	2 3/8"	10	5.20 lbs
C.T.O.	FG278CAD	2 7/8" Corner Barb Arm - Pressed Steel - U.S. Domestic	PS	2 7/8"	10	5.70 lbs
C.T.O.	FG400CAD	4" Corner Barb Arm - Pressed Steel - U.S. Domestic	PS	4"	5	6.40 lbs
04340-PS	FG238VCAS	2 3/8" Corner Barb Arm V - Pressed Steel	PS	2 3/8"	25, 5	6.00 lbs
04341-PS	FG278VCAS	2 7/8" Corner Barb Arm V - Pressed Steel	PS	2 7/8"	25, 5	6.30 lbs
04342-PS	C.T.O.	3 1/2" Corner Barb Arm V - Pressed Steel	PS	3 1/2"	25	6.3 lbs
04343-PS	C.T.O.	4 1/2" Corner Barb Arm V - Pressed Steel	PS	4 1/2"	25	6.6 lbs
C.T.O.	FG400VCAS	4" Corner Barb Arm V - Pressed Steel	PS	4"	5	7.00 lbs
C.T.O.	FG278VCAD	2 7/8" Corner Barb Arm V - Pressed Steel - Domestic	PS	2 7/8"	5	6.30 lbs
C.T.O.	FG400VCAD	4" Corner Barb Arm V - Pressed Steel - Domestic	PS	4"	5	7.00 lbs
C.T.O.	FG238VCAGI	2 3/8" Corner Barb Arm V - Galv. Iron	GI	2 3/8"	5	7.00 lbs
C.T.O.	FG278VCAGI	2 7/8" Corner Barb Arm V - Galv. Iron	GI	2 7/8"	5	8.00 lbs
C.T.O.	FG400VCAGI	4" Corner Barb Arm V - Galv. Iron	GI	4"	5	10.60 lbs

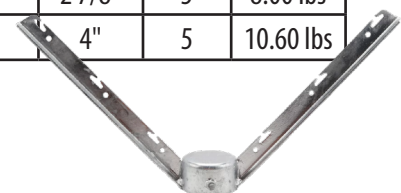

## Saddle Clamps

CAD Item #	US Item #	Description	Material	Length	#/Bag	Weight
C.T.O.	FG1313SCLAM	1 3/8" x 1 3/8" Saddle Clamp	PS	1 3/8"	100	0.50 lbs
C.T.O.	FG1515SCLAM	1 5/8" x 1 5/8" Saddle Clamp	PS	1 5/8"	50	0.61 lbs
C.T.O.	FG1717SCALM	1 7/8" x 1 7/8" Saddle Clamp	PS	1 7/8"	50	0.80 lbs



## Panel Clamps

CAD Item #	US Item #	Description	Material	Length	#/Bag	Weight
04080-PS	FG1313PCLAM	1 3/8" x 1 3/8" Panel Clamp	PS	1 3/8"	100	0.50 lbs
04081-PS	FG1515PCLAM	1 5/8" x 1 5/8" Panel Clamp	PS	1 5/8"	100, 50	0.63 lbs
04082-PS	FG1717PCLAM	1 7/8" x 1 7/8" Panel Clamp	PS	1 7/8"	100, 50	0.75 lbs
C.T.O.	FG2315PCLAM	2 3/8" x 1 5/8" Panel Clamp	PS	2 3/8"	50	0.82 lbs
C.T.O.	FG2715PCLAM	2 7/8" x 1 5/8" Panel Clamp	PS	2 7/8"	50	0.97 lbs



## Brace Clamps

CAD Item #	US Item #	Description	Material	Length	#/Bag	Weight
C.T.O.	FG1313BCLAM	1 3/8" x 1 3/8" Brace Clamp	PS	1 3/8"	100	0.28 lbs
C.T.O.	FG1513BCLAM	1 5/8" x 1 3/8" Brace Clamp	PS	1 5/8"	100	0.34 lbs
C.T.O.	FG1515BCLAM	1 5/8" x 1 5/8" Brace Clamp	PS	1 5/8"	100	0.45 lbs
C.T.O.	FG1713BCLAM	1 7/8" x 1 3/8" Brace Clamp	PS	1 7/8"	100	0.39 lbs
C.T.O.	FG1715BCLAM	1 7/8" x 1 5/8" Brace Clamp	PS	1 7/8"	100	0.46 lbs
04100-PS	FG2315BCLAM	2 3/8" x 1 5/8" Brace Clamp	PS	2 3/8"	50	0.56 lbs
04101-PS	FG2715BCLAM	2 7/8" x 1 5/8" Brace Clamp	PS	2 7/8"	50	0.64 lbs



## Line Rail Clamps

CAD Item #	US Item #	Description	Width	Length	#/Bag	Weight
C.T.O.	FG1313RCLAM	1 3/8" x 1 3/8" Line Rail Clamp	1 3/8"	1 3/8"	50	0.54 lbs
C.T.O.	FG1513RCLAM	1 5/8" x 1 3/8" Line Rail Clamp	1 3/8"	1 5/8"	50	0.48 lbs
C.T.O.	FG1515RCLAM	1 5/8" x 1 5/8" Line Rail Clamp	1 5/8"	1 5/8"	50	0.49 lbs
04108-PS	FG1713RCLAM	1 7/8" x 1 3/8" Line Rail Clamp	1 3/8"	1 7/8"	50	0.53 lbs
04110-PS	FG1715RCLAM	1 7/8" x 1 5/8" Line Rail Clamp	1 5/8"	1 7/8"	50	0.63 lbs
04111-PS	FG2315RCLAM	2 3/8" x 1 5/8" Line Rail Clamp	1 5/8"	2 3/8"	50	0.70 lbs
04112-PS	FG2715RCLAM	2 7/8" x 1 5/8" Line Rail Clamp	1 5/8"	2 7/8"	50	0.77 lbs
C.T.O.	FG4015RCLAM	4" x 1 5/8" Line Rail Clamp	1 5/8"	4"	50	0.87 lbs



## Automatic Gate Closer

CAD Item #	US Item #	Description	Material	Length	#/Bag	Weight
05136-WW	C.T.O.	1 7/8" Auto Gate Closer; Fits 1 3/8" Frame	AL	1 7/8"	12	1.3 lbs
05138-WW	C.T.O.	2 3/8" Auto Gate Closer; Fits 1 3/8" Frame	AL	2 3/8"	12	1.5 lbs

## Post Collars

CAD Item #	US Item #	Description	Type	Length	#/Bag	Weight
05142-BB	C.T.O.	2 3/8" x 3/4" Ind. Gate Post Collar	BackBolt	2 3/8"	25	1.6 lbs
05144-BB	C.T.O.	2 7/8" x 3/4" Ind. Gate Post Collar	BackBolt	2 7/8"	20	3.2 lbs
05146-BB	C.T.O.	3 1/2" x 3/4" Ind. Gate Post Collar	BackBolt	3 1/2"	10	1.9 lbs
05147-BB	C.T.O.	4 1/2" x 3/4" Ind. Gate Post Collar	BackBolt	4 1/2"	10	2.6 lbs
05150-BB	C.T.O.	6 5/8" x 1" Ind. Gate Post Collar	BackBolt	6 5/8"	5	3.7 lbs
05142-HE	C.T.O.	2 3/8" x 3/4" Ind. Gate Post Collar	Hook & Eye	2 3/8"	25	1.6 lbs
05144-HE	C.T.O.	2 7/8" x 3/4" Ind. Gate Post Collar	Hook & Eye	2 7/8"	20	3.2 lbs
05146-HE	C.T.O.	3 1/2" x 3/4" Ind. Gate Post Collar	Hook & Eye	3 1/2"	10	1.9 lbs
05147-HE	C.T.O.	4 1/2" x 3/4" Ind. Gate Post Collar	Hook & Eye	4 1/2"	10	2.6 lbs
05158-PS	C.T.O.	1 5/8" x 3/4" Gate Frame Collar	Hook & Eye	1 5/8"	25	1.6 lbs



BackBolt (Top)  
Hook & Eye (Bottom)



## Hanger Bolts

CAD Item #	US Item #	Description	Type	Length	#/Bag	Weight
05172-WS	C.T.O.	5/8" x 6" Hanger Bolt	With Seat	5/8"	100	0.7 lbs
05176-WS	C.T.O.	5/8" x 10" Hanger Bolt	With Seat	5/8"	50	1.0 lbs
05178-WS	C.T.O.	5/8" x 12" Hanger Bolt	With Seat	5/8"	50	1.2 lbs
05182-WS	C.T.O.	3/4" x 6" Hanger Bolt	With Seat	3/4"	50	1.1 lbs
05182-WO	C.T.O.	3/4" x 6" Hanger Bolt	Without Seat	3/4"	50	1.1 lbs
05184-WS	C.T.O.	3/4" x 9" Hanger Bolt	With Seat	3/4"	25	1.6 lbs
05184-WO	C.T.O.	3/4" x 9" Hanger Bolt	Without Seat	3/4"	25	1.6 lbs
05188-WS	C.T.O.	3/4" x 12" Hanger Bolt	With Seat	3/4"	25	1.7 lbs
05188-WO	C.T.O.	3/4" x 12" Hanger Bolt	Without Seat	3/4"	25	1.7 lbs
05194-WO	C.T.O.	1" x 9" Hanger Bolt	Without Seat	1"	25	2.7 lbs



## Pro Clamps - Straight Coupling

CAD Item #	US Item #	Description	Length	#/Bag	Weight
04510-MA	FG158COUP	1 5/8" Straight Coupling	1 5/8"	35	1.20 lbs
04512-MA	FG178COUP	1 7/8" Straight Coupling	1 7/8"	30	1.40 lbs



## Pro Clamps - Socket Tees

CAD Item #	US Item #	Description	Length	#/Bag	Weight
04540-MA	FG158SOCT	1 5/8" Single Socket Cross	1 5/8"	40	1.40 lbs
04542-MA	FG178SOCT	1 7/8" Single Socket Cross	1 7/8"	30	1.40 lbs
04580-MA	FG1583SOCT	1 5/8" 3-Socket Tee	1 5/8"	25	2.10 lbs
04582-MA	FG1783SOCT	1 7/8" 3-Socket Tee	1 7/8"	25	2.12 lbs

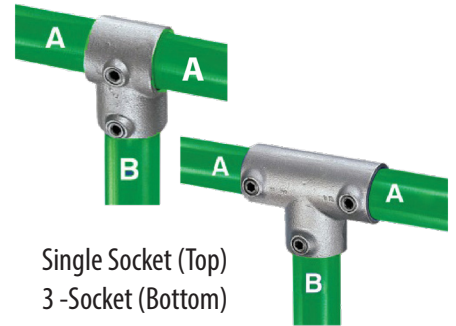

Single Socket (Top)  
3-Socket (Bottom)

## Pro Clamps - Multi-Socket Cross

CAD Item #	US Item #	Description	Length	#/Bag	Weight
04530-MA	FG1582SOCC	1 5/8" 2-Socket Cross	1 5/8"	30	1.66 lbs
04532-MA	FG1782SOCC	1 7/8" 2-Socket Cross	1 7/8"	20	1.90 lbs
04534-MA	FG1583SOCC	1 5/8" 3-Socket Cross	1 5/8"	20	1.00 lbs
04536-MA	FG1783SOCC	1 7/8" 3-Socket Cross	1 7/8"	15	1.00 lbs
04538-MA	FG1584SOCC	1 5/8" 4-Socket Cross	1 5/8"	15	1.00 lbs
04539-MA	FG1784SOCC	1 7/8" 4-Socket Cross	1 7/8"	10	2.58 lbs

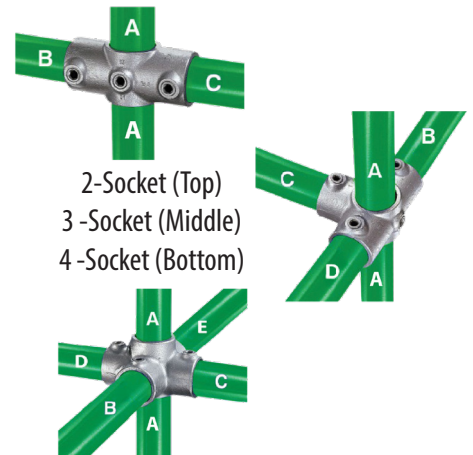

2-Socket (Top)  
3-Socket (Middle)  
4-Socket (Bottom)

## Pro Clamps - Elbows

CAD Item #	US Item #	Description	Length	#/Bag	Weight
04520-MA	FG158ELBW	1 5/8" 90 Degree Elbow	1 5/8"	30	1.68 lbs
04522-MA	FG178ELBW	1 7/8" 90 Degree Elbow	1 7/8"	25	1.70 lbs
04560-MA	FG158SOEL	1 5/8" Side Outlet Elbow	1 5/8"	25	2.20 lbs
04562-MA	FG178SOEL	1 7/8" Side Outlet Elbow	1 7/8"	25	2.25 lbs

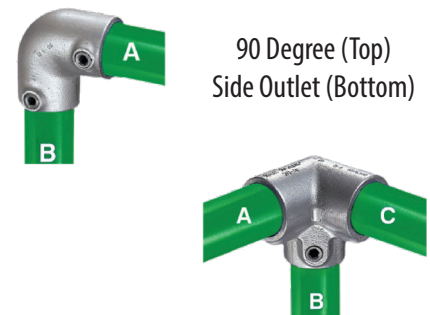

90 Degree (Top)  
Side Outlet (Bottom)

## Pro Clamps - Side Outlet 90 Degree

CAD Item #	US Item #	Description	Length	#/Bag	Weight
04570-MA	FG158SOTE	1 5/8" Side Outlet Tee 90°	1 5/8"	25	1.62 lbs
04572-MA	FG178SOTE	1 7/8" Side Outlet Tee 90°	1 7/8"	25	1.93 lbs

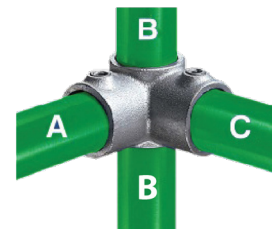

## Pro Clamps - Flanges

CAD Item #	US Item #	Description	Length	#/Bag	Weight
04550-MA	FG158FLAN	1 5/8" Flange	1 5/8"	25	1.44 lbs
04552-MA	FG178FLAN	1 7/8" Flange	1 7/8"	25	1.50 lbs
04554-MA	FG1582FLAN	1 5/8" 2-Hole Flange	1 5/8"	25	1.40 lbs
04556-MA	FG1782FLAN	1 7/8" 2-Hole Flange	1 7/8"	25	1.50 lbs

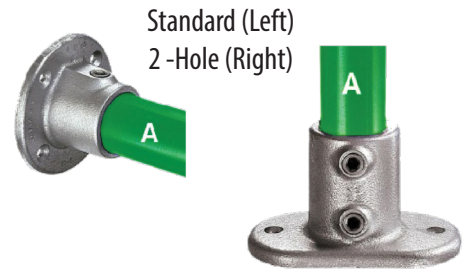

## Pro Clamps - Swivel Socket

CAD Item #	US Item #	Description	Length	#/Bag	Weight
04624-MA	FG158SSSF	1 5/8" Single Swivel Socket	1 5/8"	35	1.70 lbs
04626-MA	FG178SSSF	1 7/8" Single Swivel Socket	1 7/8"	25	1.89 lbs
04620-MA	FG158DSSF	1 5/8" Double Swivel Socket	1 5/8"	15	2.87 lbs
04622-MA	FG178DSSF	1 7/8" Double Swivel Socket	1 7/8"	10	3.27 lbs

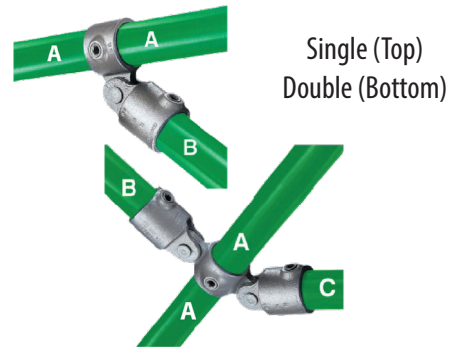

## Pro Clamps - Fittings

CAD Item #	US Item #	Description	Length	#/Bag	Weight
04610-MA	FG178EFRF	1 7/8" Eves Fitting for Roof	1 7/8"	6	1.16 lbs
04612-MA	FG178RFRT	1 7/8" Ridge Fitting for Rooftop	1 7/8"	6	1.00 lbs
04636-MA	C.T.O.	1 7/8" Eye Fitting	1 7/8"	70	

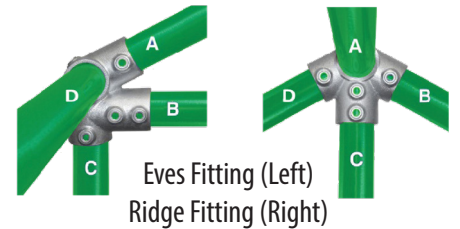

## Pro Clamps - Offset Tab Panel

CAD Item #	US Item #	Description	Length	#/Bag	Weight
04630-MA	FG1580DTP	1 5/8" Offset Single Tab Panel w/Slot	1 5/8"	50	0.71 lbs
04632-MA	FG1780DTP	1 7/8" Offset Double Tab Panel w/Slot	1 7/8"	50	0.94 lbs

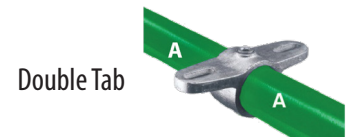

## Pro Clamps - Misc.

CAD Item #	US Item #	Description	Length	#/Bag	Weight
04628-MA	FG178MSSM	1 7/8" Male Single Socket Member	1 7/8"	80	0.74 lbs
04634-MA	FG178RSF	1 7/8" Rail Support	1 7/8"	30	1.23 lbs

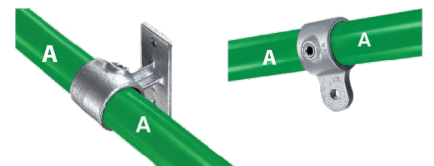

## 1 5/8" Drop Latch Catch

CAD Item #	US Item #	Description	Length	#/Bag	Weight
05040-MA	C.T.O.	1 5/8" Drop Latch Catch	1 5/8"	25	1.20 lbs
05042-MA	C.T.O.	1 7/8" Drop Latch Catch	1 7/8"	25	1.50 lbs
05044-MA	C.T.O.	2 3/8" Drop Latch Catch	2 3/8"	25	1.70 lbs
05046-MA	C.T.O.	2 7/8" Drop Latch Catch	2 7/8"	25	2.00 lbs
05048-MA	C.T.O.	3 1/2" Drop Latch Catch	3 1/2"	25	2.30 lbs



## Drop Latch

CAD Item #	US Item #	Description	Material	Length	#/Bag	Weight
05052-MA	C.T.O.	1 5/8" Drop Latch	MA	5/8"	25	1.20 lbs



## Pool Latch

CAD Item #	US Item #	Description	Length	#/Bag	Weight
05060-BL	C.T.O.	1 3/8" x 1 7/8" Push Down Gate Latch	1 3/8"	1	3.00 lbs
05062-BL	C.T.O.	1 3/8" x 2 3/8" Push Down Gate Latch	1 3/8"	1	3.50 lbs



## Latch Assemblies

CAD Item #	US Item #	Description	Length	#/Bag	Weight
05084-PS	C.T.O.	Drop Pin Latch Assembly		25	1.20 lbs
05086-PS	C.T.O.	1 3/8" x 42" E-Z Latch Assembly	1 3/8"	10	2.60 lbs



## Gate Keeper

CAD Item #	US Item #	Description	Material	#/Bag	Weight
05750-WW	C.T.O.	1 5/8" or 1 7/8" Gate Keeper	PS,MA	20	1.20 lbs



## Luggs

CAD Item #	US Item #	Description	Length	#/Bag	Weight
05750-WW	C.T.O.	1 5/8" or 1 7/8" Gate Keeper	3/4"	25	0.30 lbs

## Tires

CAD Item #	US Item #	Description	Length	#/Bag	#/Pallet	Weight
05800-PS	C.T.O.	6" Rubber Tired Wheel	6"	10	250	1.20 lbs
05802-PS	C.T.O.	8" Rubber Tired Wheel	8"	10	250	1.50 lbs
05804-PS	C.T.O.	10" Rubber Tired Wheel	10"	5		1.70 lbs



## Pneumatic Wheel (Rut Runner)

CAD Item #	US Item #	Description	Length	#/Bag	Weight
05852-PS	C.T.O.	1 5/8" Frame, 10" Wheel (12")	1 5/8"	1	14.10 lbs

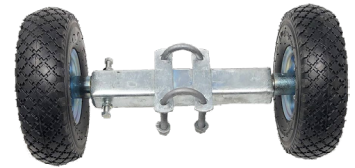

## Chain Link Hanger

CAD Item #	US Item #	Description	Weight
06271-PS	C.T.O.	Chain Link Hanger	1.00 lbs

## Turnbuckles

CAD Item #	US Item #	Description	Length	#/Bag	Weight
06272-PS	C.T.O.	3/8" x 6" Zinc Plated Eye-to-Eye Turnbuckle	1 5/8"	1	0.50 lbs



## Lock Boxes

CAD Item #	US Item #	Description	Type	Weight
06290-PS	C.T.O.	Lock Box - 2 1/8" Hole 2 3/4" Offset	1 Hole	3.00 lbs
06289-PS	C.T.O.	2 Hole Lock Box - 2 1/8" Hole 2 3/4" Offset	2 Hole	3.00 lbs

1 Hole (Left)  
2 Hole (Right)



## Wood-To-Steel Fittings

CAD Item #	US Item #	Description	Length	#/Bag	Weight
04408-PS	C.T.O.	1 7/8" x 6" Wood-Steel Adaptor	1 7/8"	25	1.00 lbs
04409-PS	C.T.O.	2 3/8" x 6" Adaptors - Line Post	2 3/8"	25	4.50 lbs
04412-PS	C.T.O.	2 7/8" x 8" Wood-Steel Adaptor	2 7/8"	25	0.70 lbs
04411-PS	C.T.O.	2 3/8" x 6" Wood-Steel Adaptor	2 3/8"	25	4.50 lbs
04420-PS	C.T.O.	1 7/8" Corner Wood Brackets	1 7/8"	25	4.00 lbs
04430-PS	C.T.O.	2 3/8" x 1 5/8" End Clamp - Wood	2 3/8"	25	4.00 lbs
04432-PS	C.T.O.	2 7/8" x 1 5/8" End Clamp - Wood	2 7/8"	25	4.00 lbs



Adaptor Plate (Top)  
Corner Bracket (Middle)  
End Clamp (Bottom)

# PROLINK SUPPLY

## Ornamental

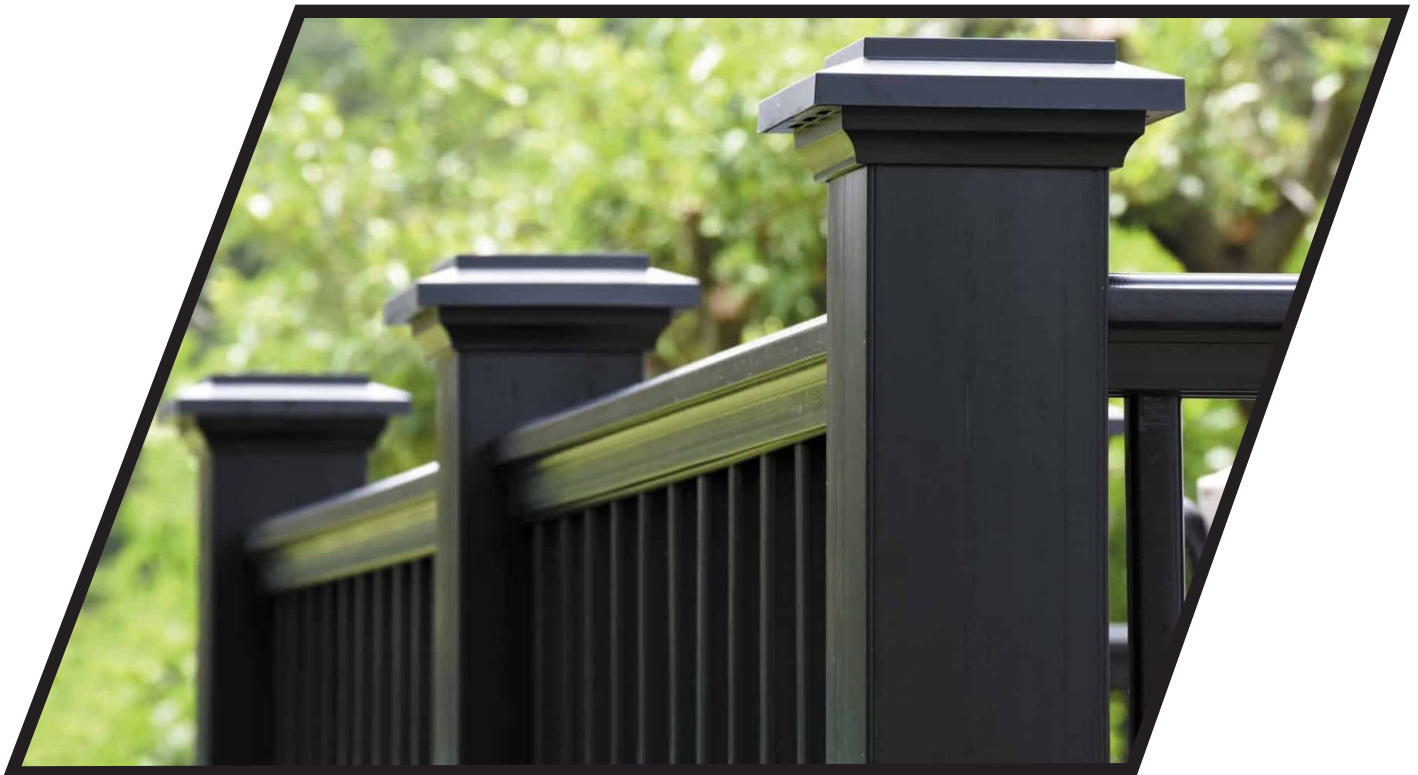

## Versai 3-Rail Flat Top/Extended Picket Bottom

CAD Item #	US Item #	Description	Type	Height	Width	Weight
16113VP	ORF34903VFTPR	34"h x 90.5" Versai 3 Rail Flat Top/Ext. Picket Bottom Panel - Res.	Panel	34"	90.5"	34.00 lbs
16114VP	ORF46903VFTPR	46"h x 90.5" Versai 3 Rail Flat Top/Ext. Picket Bottom Panel - Res.	Panel	46"	90.5"	40.00 lbs
16115VP	ORF58903VFTPR	58"h x 90.5" Versai 3 Rail Flat Top/Ext. Picket Bottom Panel - Res.	Panel	58"	90.5"	45.00 lbs
16116VP	ORF70903VFTPR	70"h x 90.5" Versai 3 Rail Flat Top/Ext. Picket Bottom Panel - Res.	Panel	70"	90.5"	52.00 lbs
C.T.O.	ORF46053VFTGR	46"h x 58.5" Versai 3 Rail Flat Top/Ext. Picket Bottom Gate - Res.	Gate	46"	58.5"	36.00 lbs
C.T.O.	ORF70053VFTGR	70"h x 58.5" Versai 3 Rail Flat Top / Ext. Picket Bottom Gate - Res.	Gate	70"	58.5"	49.00 lbs
16114VG	C.T.O.	46"h x 46.5" Versai 3 Rail Flat Top / Ext. Picket Bottom Arch Gate	Gate	46"	46.5"	30.00 lbs
16115VG	ORF58043VFTAG	58"h x 46.5" Versai 3 Rail Flat Top / Ext. Picket Bottom Arch Gate	Gate	58"	46.5"	38.00 lbs
16116VG	ORF70043VFTAG	70"h x 46.5" Versai 3 Rail Flat Top / Ext. Picket Bottom Arch Gate	Gate	70"	46.5"	43.00 lbs

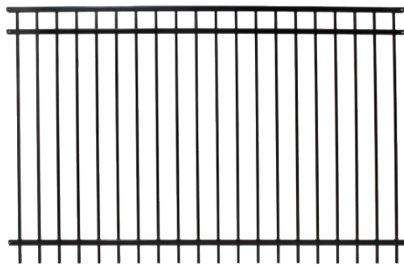

Panel (FlatTop)

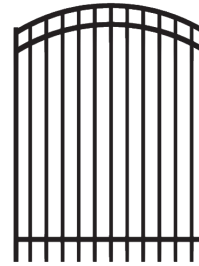

Gate (Arch)

## Versai Flat Top/Extended Picket Bottom

CAD Item #	US Item #	Description	Type	Height	Width	Weight
C.T.O.	ORF46902VFTPR	46"h x 90.5" Versai 2 Rail Flat Top/Extended Picket Bottom Panel	Panel	46"	90.5"	34.00 lbs

## Versai Flat Top/Flat Bottom 3-Rail

CAD Item #	US Item #	Description	Height	Width	Weight
C.T.O.	ORF46903VFTFB	46"h x 90.5" Versai 3 Rail Flat Top / Flat Bottom Panel - Residential	46"	90.5"	40.00 lbs
16114VW	ORF46043VFTAG	46"h x 46.5" Versai 3 Rail Flat Top / Flat Bottom Arch Gate - Residential	46"	46.5"	31.00 lbs
16115VW	C.T.O.	46"h x 46.5" Versai 3 Rail Flat Top / Flat Bottom Arch Gate - Residential	46"	46.5"	36.00 lbs
C.T.O.	ORF34043VFTBG	34"h x 46.5" Versai 3 Rail Flat Top / Flat Bottom Gate - Residential	34"	46.5"	24.00 lbs
C.T.O.	ORF46043VFTBG	46"h x 46.5" Versai 3 Rail Flat Top / Flat Bottom Gate - Residential	46"	46.5"	30.00 lbs
C.T.O.	ORF58043VFTBG	58"h x 46.5" Versai 3 Rail Flat Top / Flat Bottom Gate - Residential	58"	46.5"	34.00 lbs
C.T.O.	ORF70043VFTBG	70"h x 46.5" Versai 3 Rail Flat Top / Flat Bottom Gate - Residential	70"	46.5"	40.00 lbs
C.T.O.	ORF46053VFTBG	46"h x 58.5" Versai 3 Rail Flat Top / Flat Bottom Gate - Residential	46"	58.5"	30.00 lbs
16116VW	ORF70043AFTFB	70"h x 46.5" Versai 3 Rail Flat Top Arched/ Flat Bottom Gate - Res	70"	46.5"	40.00 lbs

## Versai Flat Top 3-Rail (V2)

CAD Item #	US Item #	Description	Type	Height	Width	Weight
16214VP	C.T.O.	46" x 90.5" V2 Panel - Flat Top (3-Rail)	Panel	46"	90.5"	68.00 lbs
16216VP	C.T.O.	70" x 90.5" V2 Panel - Flat Top (3-Rail)	Panel	70"	90.5"	91.00 lbs

## Versai Flat Top/Flat Bottom 2-Rail

CAD Item #	US Item #	Description	Type	Height	Width	Weight
C.T.O.	ORF46902VFTFB	46" h x 90.5" Versai 2 Rail Flat Top/Bottom Panel -Residential	Panel	46"	90.5"	34.00 lbs
C.T.O.	ORF34042VFTBG	34" h x 46.5" oto Versai 2 Rail Flat Top / Flat Bottom Gate -Residential	Gate	34"	46.5"	21.00 lbs
C.T.O.	ORF46042VFTBG	46" h x 46.5" oto Versai 2 Rail Flat Top / Flat Bottom Gate -Residential	Gate	46"	46.5"	27.00 lbs
C.T.O.	ORF58042VFTBG	58" h x 46.5" oto Versai 2 Rail Flat Top / Flat Bottom Gate -Residential	Gate	58"	46.5"	33.00 lbs

## Versai 2-Rail Extended Picket (Residential)

CAD Item #	US Item #	Description	Type	Height	Width	Weight
C.T.O.	ORF46902VEPPR	46" h x 90.5" Versai 2 Rail Extended Picket Panel -Residential	Panel	46"	90.5"	34.00 lbs

## Versai 3-Rail Extended Picket (Residential)

CAD Item #	US Item #	Description	Height	Width	Weight
C.T.O.	ORF46903VEPPR	46" h x 90.5" Versai 3 Rail Extended Picket Panel	46"	90.5"	40.00 lbs
C.T.O.	ORF58903VEPPR	58" h x 90.5" Versai 3 Rail Extended Picket Panel	58"	90.5"	45.00 lbs
C.T.O.	ORF70903VEPPR	70" h x 90.5" Versai 3 Rail Extended Picket Panel	70"	90.5"	52.00 lbs
C.T.O.	ORF46043VEPGR	46" h x 46.5" oto Versai 3 Rail Extended Picket Gate	46"	46.5"	30.00 lbs
C.T.O.	ORF58043VEPGR	58" h x 46.5" oto Versai 3 Rail Extended Picket Gate	58"	46.5"	38.00 lbs
C.T.O.	ORF70043VEPGR	70" h x 46.5" oto Versai 3 Rail Extended Picket Gate	70"	46.5"	40.00 lbs
C.T.O.	ORF46043VEPAG	46" h x 46.5" oto Versai 3 Rail ARCH Extended Picket Gate	46"	46.5"	31.00 lbs
C.T.O.	ORF58043VEPAR	58" h x 46.5" oto Versai 3 Rail ARCH Extended Picket Gate	58"	46.5"	38.00 lbs
C.T.O.	ORF70043VEPAG	70" h x 46.5" oto Versai 3 Rail ARCH Extended Picket Gate	70"	46.5"	40.00 lbs

2 Rail Flat Top/Bottom

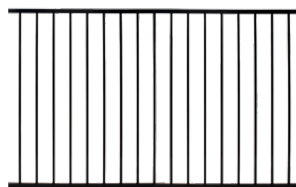

3 Rail Extended Picket

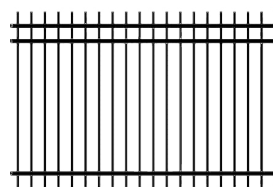

## Versai 3-Rail Pressed Spear (Residential)

CAD Item #	US Item #	Description	Height	Width	Weight
16144VP	C.T.O.	46" h x 90.5" Versai 3 Rail Pressed Spear Panel	46"	90.5"	40.00 lbs
16145VP	C.T.O.	58" h x 90.5" Versai 3 Rail Pressed Spear Panel	58"	90.5"	45.00 lbs
16146VP	ORF70903VPSPR	70" h x 90.5" Versai 3 Rail Pressed Spear Panel	70"	90.5"	52.00 lbs
16146VW	ORF70043VPSGR	70" h x 46.5" Versai 3 Rail Pressed Spear Gate	70"	46.5"	40.00 lbs
16146VG	ORF70043VPSAG	70" h x 46.5" Versai 3 Rail ARCH Pressed Spear Gate	70"	46.5"	40.00 lbs

## Versai 3-Rail (V2) Pressed Spear

CAD Item #	US Item #	Description	Height	Width	Weight
16244VP	C.T.O.	46" x 90.5" V2 Panel - Pressed Spear (3-Rail)	46"	90.5"	68.00 lbs
16248VP	C.T.O.	94" x 90.5" V2 Panel - Pressed Spear (3-Rail)	94"	90.5"	114.00 lbs

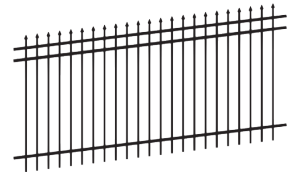

## Versai Brackets

CAD Item #	US Item #	Description	OC Spacing	Width	#/Bag	Weight
16181XD	ORF104BRKT	EX-104 One-Direction Bracket	92-5/8" - 93-3/8"		6	0.80 lbs
16181XS	ORF104SBRKT	EXS-104 One-Direction Swivel Bracket	92-5/8" - 93-3/8"		6	1.70 lbs
16182XD	ORF204BRKT	EXW-204 Two-Direction Brackets	92-5/8" - 93-3/8"		3	0.80 lbs
16183XT	ORF304BRKT	EXW-304 Three-Direction Brackets	92-5/8" - 93-3/8"		6	1.20 lbs
C.T.O.	ORF10496BRKT	EX-104 96" OC Ext. One Direction Brackets	94-7/8" to 96"	96"	6	1.50 lbs
C.T.O.	ORF20496BRKT	EXW-204 96" OC Ext. Two Direction Brackets	94-7/8" to 96"	96"	6	2.10 lbs
C.T.O.	ORF30496BRKT	EXW-304 96" OC Ext. Three Direction Brackets	94-7/8" to 96"	96"	6	2.25 lbs

One-Direction



Two-Direction



## V2 Fittings

CAD Item #	US Item #	Description	Width	#/Bag	Weight
16541BD	C.T.O.	2.5" X 2.5" Ornamental Black Dome Cap	2.5"		0.17 lbs
15204	C.T.O.	3" X 3" Ornamental Black Dome Cap	3"		0.20 lbs
16281XD	C.T.O.	Exterior One Direction Bracket (EX-106)		6	2.00 lbs
16282XD	C.T.O.	Exterior Two Direction Bracket (EX-206)		6	2.00 lbs
16283XT	C.T.O.	Exterior Three Direction Bracket (EX-306)		6	2.50 lbs

Exterior One-Direction



Dome Cap



## Versai Ornamental Posts

CAD Item #	US Item #	Description	Gauge	Height	Width	Weight
16514	ORF27216POST	2" x 2" x 72" Black Ornamental Post	16	72"	2"	4.40 lbs
16516	ORF28416POST	2" x 2" x 84" Black Ornamental Post	16	84"	2"	5.13 lbs
16517	ORF29616POST	2" x 2" x 96" Black Ornamental Post	16	96"	2"	5.86 lbs
C.T.O.	ORF210816POST	2" x 2" x 108" Black Ornamental Post	16	108"	2"	6.59 lbs
C.T.O.	ORF25084POSTI	2-1/2" x 2-1/2" x 84" Black Ornamental Post	16	84"	2 1/2"	12.20 lbs
16524	ORF25096POSTI	2-1/2" x 2-1/2" x 96" Black Ornamental Post	16	96"	2 1/2"	14.00 lbs
C.T.O.	ORF25120POSTI	2-1/2" x 2-1/2" x 120" Black Ornamental Post	14	108"	2 1/2"	38.80 lbs
C.T.O.	ORF25216BAPT	2" x 52" Square Post with Base Black	16	52"	2"	11.00 lbs
C.T.O.	ORF26416BAPT	2" x 64" Square Post with Base - Black	16	64"	2"	12.10 lbs
C.T.O.	ORF27416BAPT	2" x 74" Square Post with Base - Black	16	74"	2"	13.30 lbs

Plated (Left)  
Standard (Right)



## Versai Pressed Dome Caps

CAD Item #	US Item #	Description	Width	Weight
C.T.O.	ORF112DCAP	1 1/2" x 1 1/2" Black Post Cap	1 1/2"	0.05 lbs
16540BD	ORF200DCAP	2" x 2" Black Post Cap	2"	0.13 lbs
16541BD	ORF212DCAP	2 1/2" x 2 1/2" Black Post Cap	2 1/2"	0.13 lbs
C.T.O.	ORF300DCAP	3" x 3" Black Post Cap	3"	0.20 lbs
C.T.O.	OBK400CAP	4" x 4" Black Post Cap	4"	0.33 lbs
C.T.O.	OBK600CAP	6" x 6" Black Post Cap	6"	0.45 lbs
C.T.O.	ORF5858PLUG	5/8" x 5/8" Black Plastic Plug Cap	5/8"	0.01 lbs
C.T.O.	ORF100PLUG	1" x 1" Black Plastic Plug Cap	1"	0.02 lbs
C.T.O.	ORF112PLUG	1-1/2" x 1-1/2" Black Plastic Plug Cap	1 1/2"	0.04 lbs
C.T.O.	ORF200PLUG	2" x 2" Black Plastic Plug Cap	2"	0.10 lbs

V1 Cap



## Versai Gate Hinges

CAD Item #	US Item #	Description	Width	Weight
16613	C.T.O.	2" Gate Post Hinge (Pair)	2"	2.00 lbs
16614	C.T.O.	2.5" Gate Post Hinge (Pair)	2.5"	2.50 lbs
16611	C.T.O.	1.5" Gate Frame Hinge (Pair)	1.5"	2.00 lbs
16613	C.T.O.	2" Gate Frame Hinge (Pair)	2"	2.00 lbs
16614	C.T.O.	2.5" Gate Frame Hinge (Pair)	2.5"	2.50 lbs

Frame Hinge



Post Hinge



## Versai Fork Latch

CAD Item #	US Item #	Description	Width	Weight
16633	C.T.O.	1.5" x 2" Fork Latch	2"	1.00 lbs
16634	C.T.O.	1.5" x 2.5" Fork Latch	2.5"	1.50 lbs



## Versai Lock & Latch

CAD Item #	US Item #	Description	Weight
16603LL	C.T.O.	Lock & Latch	5.00 lbs

## Versai Gravity Latches

CAD Item #	US Item #	Description	Width	Weight
16620	C.T.O.	Gravity Latch Striker Plate 2"	2"	0.60 lbs
16623	C.T.O.	Latch Arm 1.5" Frame	1.5"	0.70 lbs

## Versai Pressed Dome Caps

CAD Item #	US Item #	Description	Width	Weight
16607	ORF1547GTUPB	1.5" x 47" Gate Upright	47"	5.20 lbs
C.T.O.	ORF1549GTUPB	1.5" x 49" Black Gate Upright	49"	5.40 lbs
16608	ORF1559GTUPB	1.5" x 59" Gate Upright	59"	6.50 lbs
16609	ORF1571GTUPB	1.5" x 71" Gate Upright	71"	7.90 lbs
16540GC	C.T.O.	1.5" x 1.5" Black Post Cap for Gate Uprights	1.5"	0.10 lbs
16607GE	C.T.O.	1.5" Versai Gate Ells (6 Pairs)	1.5"	8.20 lbs

## Fortress Fence Panels: Classic

CAD Item #	US Item #	Description	Width	Weight
C.T.O.	ORF7090PIPR	70" h x 90.5" w - Classic Flat Top - 2-Rail (Black)	90.5"	70.00 lbs
C.T.O.	ORF7090EPPR	70" h x 90.5" w - Extended Picket Panel - 2-Rail (Black)	90.5"	48.00 lbs

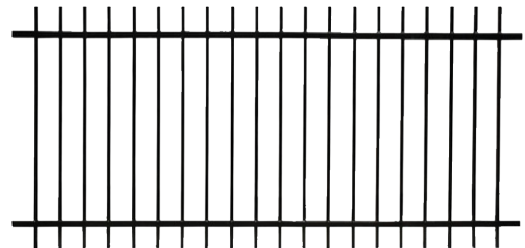

## Fortress Brackets: Classic

CAD Item #	US Item #	Description	#/Bag	Width	Weight
C.T.O.	ORHD104BRKT	HD-104-1"	4		0.64 lbs
C.T.O.	ORHD041BRKT	AL-04-1"	4		0.60 lbs
C.T.O.	ORSM081BRKT	SM-08-1"	4		0.67 lbs
C.T.O.	ORF100BKTBK	Post Bracket for 1" Square Rail - Black		1"	0.23 lbs
C.T.O.	ORF112BKTBK	Post Bracket for 1 1/2" Square Rail - Black		1 1/2"	0.45 lbs

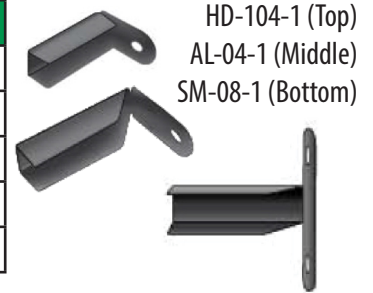

## Fortress Ornamental Gate Hardware

CAD Item #	US Item #	Description	#/Bag	Length	Width	Weight
C.T.O.	ORH1010STRBK	1" x 1" Black Clamp On Striker Latch		1"	1"	0.45 lbs
C.T.O.	ORH1515STRBK	1-1/2" x 1-1/2" Black Clamp On Striker Latch		1 1/2"	1 1/2"	0.75 lbs
C.T.O.	ORH2010STRBK	2" x 1" Black Clamp On Striker Latch		2"	1"	1.00 lbs
C.T.O.	ORH2015STRBK	2" x 1 1/2" Black Clamp On Striker Latch		2"	1 1/2"	1.19 lbs
C.T.O.	ORF150GTELL	1.5" Gate Ell (6 pair)	6			8.20 lbs
C.T.O.	ORF1547GTUPB	1.5" x 47" Black Gate Upright			47"	5.20 lbs
C.T.O.	ORF1549GTUPB	1.5" x 49" Black Gate Upright			49"	5.40 lbs
C.T.O.	ORF1559GTUPB	1.5" x 59" Black Gate Upright			59"	6.50 lbs
C.T.O.	ORF1571GTUPB	1.5" x 71" Black Gate Upright			71"	7.90 lbs



## Fortress Ornamental Square Fork Latches

CAD Item #	US Item #	Description	Length	Width	Weight
C.T.O.	ORHD1515FL	1-1/2" x 1-1/2" Black Square Fork Latch	1 1/2"	1 1/2"	0.70 lbs
C.T.O.	ORHD1520FL	1-1/2" x 2" Black Square Fork Latch	2"	1 1/2"	0.80 lbs



## Fortress Ornamental Square Fork Latches

CAD Item #	US Item #	Description	Length	Weight
C.T.O.	GBK10058GFHI	1" x 5/8" Black Square Gate Frame Hinge	1"	0.59 lbs
C.T.O.	GBK11258GFHI	1 1/2" x 5/8" Black Square Gate Frame Hinge	1 1/2"	0.76 lbs
C.T.O.	ORHD112GFHR	1 1/2" Gate Frame Hinge - Residential (RH-FH-1.5")-Pair	1 1/2"	1.70 lbs

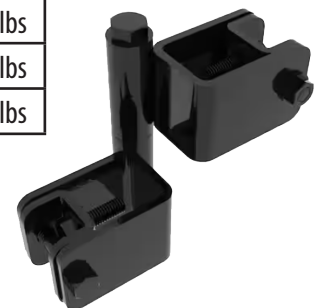

## Fortress Square Posts

CAD Item #	US Item #	Description	Height	Weight
16524	C.T.O.	2.5" x 96" Post (16 ga) - FORTRESS	96"	30.00 lbs
16536	C.T.O.	3" X 132" Post (12 ga) - FORTRESS	132"	52.30 lbs

## Fortress Square Post Hinges

CAD Item #	US Item #	Description	Length	Weight
C.T.O.	GBK20058POST	2" x 5/8" Black Square Post Hinge	2"	1.28 lbs
C.T.O.	GBK21258POST	2 1/2" x 5/8" Black Square Post Hinge	2 1/2"	1.46 lbs
C.T.O.	ORHD200PSTR	2" Post Hinge - Black Residential (RH-MH-2")- Pair	2"	2.20 lbs
C.T.O.	ORHD212PSTR	2-1/2" Post Hinge - Black Residential (RH-MH-2.5") - Pair	2 1/2"	2.60 lbs



## Multi-Brand Ornamental Accessories

CAD Item #	US Item #	Description	#/Bag	Weight
C.T.O.	ORF58217BALBK	5/8" x #217 Black Quad Finial with Ball		0.10 lbs
C.T.O.	ORFFLEURBK	Finial - Fleur De Lis 5/8" Black (Box of 20)	20	9.00 lbs
C.T.O.	ORFQUADFBK	Finial - Quad 5/8" Black (Box of 20)	20	8.80 lbs
C.T.O.	ORFTRIADBK	Finial - Triad 5/8" Black (Box of 20)	20	8.80 lbs
C.T.O.	ORFRING	Versai Res Ring (Box of 10)	10	4.40 lbs
C.T.O.	ORF500PBCVR	5" Post Base Cover (2 pc)	2	1.00 lbs

Black Quad Finial



## Proguard Metal Fencing

CAD Item #	US Item #	Description	Length	Weight
15715	PGFPSCAPBK	ProGuard Top Cap - One Post		0.59 lbs
15720	PGFPDCAPBK	ProGuard Top Cap - Two Posts		0.76 lbs
15705	PGFP2096BPST	ProGuard Fence Post (20ga)	96"	6.77 lbs
15710	PGFP2080BPST	ProGuard Fence Rail (20ga)	60"	5.47 lbs
15700	PGFP041066PMB	ProGuard Fence Sheet (24ga)	66"	17.42 lbs

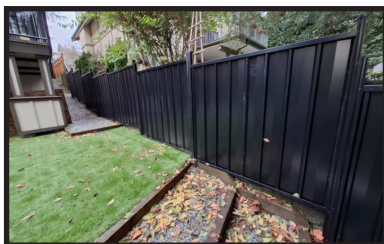
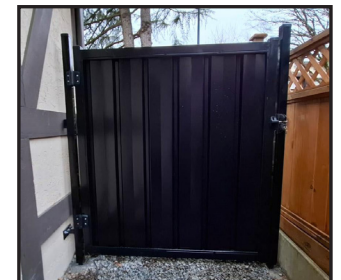

## Ameristar® Montage® 3-Rail

CAD Item #	US Item #	Description	Weight
C.T.O.	ORA04083MMJPB	4' x 8' Montage Majestic 3-Rail Panel Black - RMB346	42.00 lbs
C.T.O.	ORA05083MMJPB	5' x 8' Montage Majestic 3-Rail Panel Black - RMB358	49.00 lbs
C.T.O.	ORA06083MMJPB	6' x 8' Montage Majestic 3-Rail Panel Black - RMB370	55.00 lbs
C.T.O.	ORA06083MCEPB	6'h x 8'w Montage Classic 3-Rail Ext 4" Gap Panel Black - RCB370	55.00 lbs
C.T.O.	ORA4043MMGSB	4'h x 45"oto Montage Majestic 3-Rail SWG Black - WMB346-48	28.00 lbs
C.T.O.	ORA5043MMGSB	5'h x 45"oto Montage Majestic 3-Rail SWG Black - WMB358-48	33.00 lbs
C.T.O.	ORA6043MMGSB	6'h x 45"oto Montage Majestic 3-Rail SWG Black - WMB370-48	38.00 lbs
C.T.O.	ORA06043MPCSW	6 h x 45"oto Montage Plus Classic 3-Rail SWG Black - WCB370-48	38.00 lbs

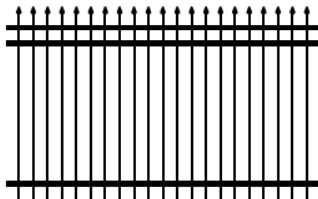
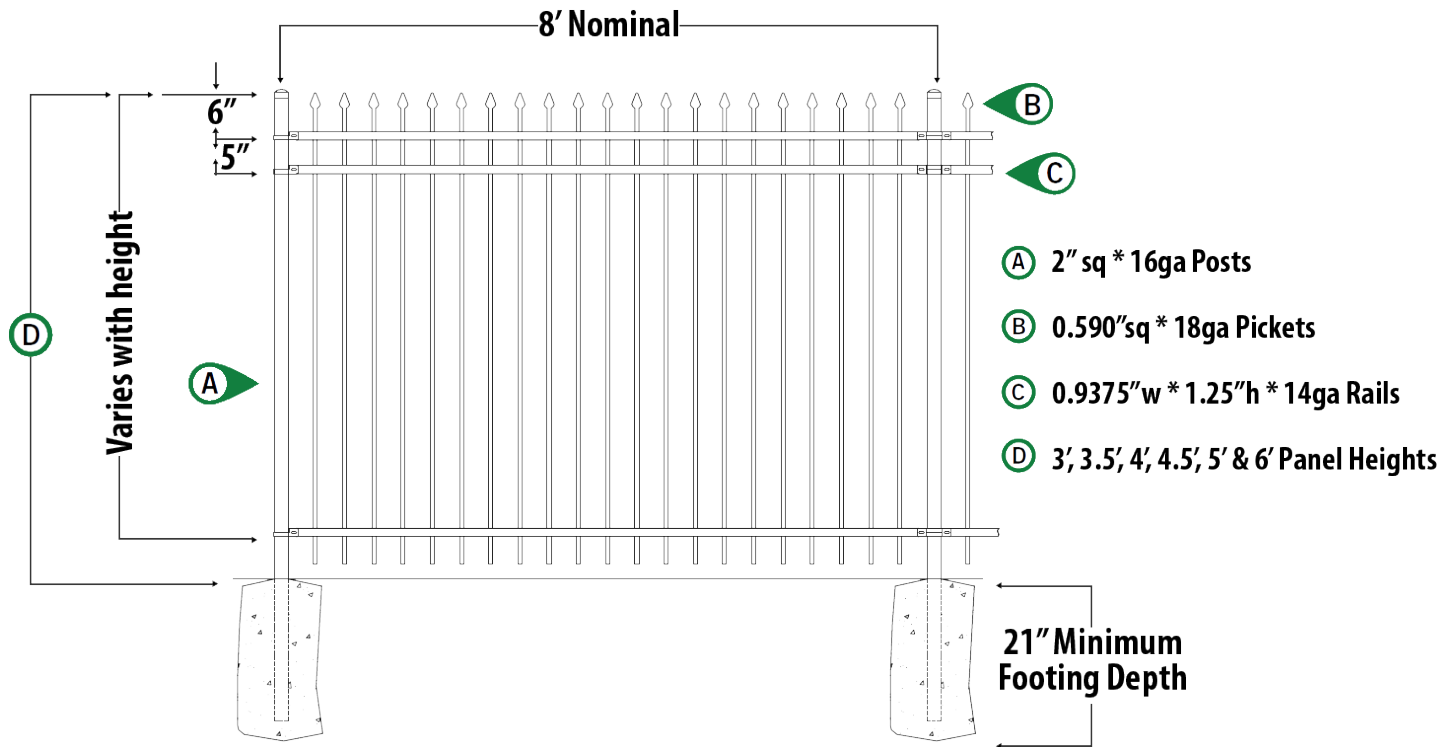

Classic (Left)  
Majestic (Right)

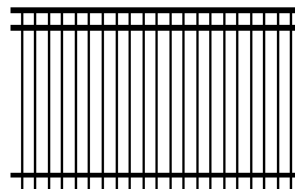

## Ameristar® Montage® Posts

CAD Item #	US Item #	Description	Weight
C.T.O.	ORA2069POSTB	2" x 5'9" Square Post 16ga Black - WPB20069	10.00 lbs
C.T.O.	ORA2081POSTB	2" x 6'9" Square Post 16ga Black - WPB20081	11.00 lbs
C.T.O.	ORA2093POSTB	2" x 7'9" Square Post 16ga Black - WPB20093	13.00 lbs

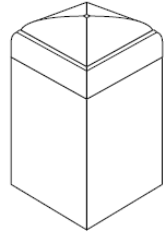

## Ameristar® Montage® Brackets (Bag of 2)

CAD Item #	US Item #	Description	Weight
C.T.O.	ORAMUNIVBB	Montage Universal Bracket fits 2" Post Black - BB102R	0.38 lbs
C.T.O.	ORAMOLINBB	Montage Line Bracket fits 2" Post Black - BB104R	0.73 lbs
C.T.O.	ORAMOFTMBB	Montage Flat Mount Bracket fits 2" Post Black - BB102R	0.25 lbs

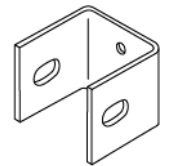
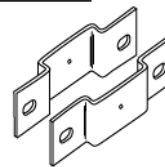
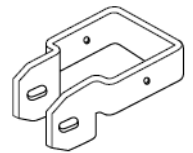

## Ameristar® Gate Hardware

CAD Item #	US Item #	Description	Weight
C.T.O.	ORA114GFHIB	1-1/4" Square Gate Frame Hinge Black - HB404N	0.06 lbs
C.T.O.	ORA200POSTB	2" Square Post Hinge Black - HB403N	0.46 lbs
C.T.O.	ORA114LAHAB	1-1/4" Square Latch Hanger Black - HB301N	0.50 lbs
C.T.O.	ORA114FORKB	1-1/4" Black Square Fork Only - HB401N	0.34 lbs
C.T.O.	ORA200FORKB	2" Black Square Fork Latch - HB402N	0.42 lbs
C.T.O.	ORA048CANE	48" Cane Bolt Black for Gates - HB316N	5.00 lbs

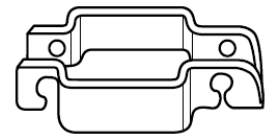
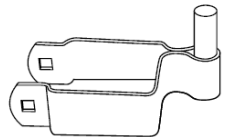
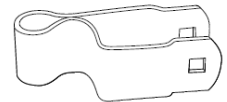

# PRO LINK SUPPLY

## Vinyl

---



A reminder that the colour codes (XX) for vinyl products are as follows, options vary per SKU:

	<b>WH- WHITE</b>		<b>TN- TAN/ SAND</b>		<b>CY- CLAY</b>
	<b>DW- DARK WALNUT</b>		<b>DS- DARK SEQUOIA</b>		<b>WA- WEATHERED ASPEN</b>
	<b>SG- SLATE GREY</b>		<b>DF- DRIFTWOOD/ MESQUITE</b>		<b>CC- COASTAL CEDAR</b>

## 2-Rail PVC Posts

CAD Item #	US Item #	Description	Colour	Height	#/Bag
C.T.O.	VL500060BP(XX)	5" x 5" x 5' Blank Post	DF,WH,TN,DW,CC,WA,CY,SG,DS	60"	54
VL500060PL-XX	VL500060PL(XX)	5" x 5" x 5' 2-Rail Line Post (0.135" wall)	DF,WH,TN,DW,CC,WA,CY,SG,DS	60"	54
VL500060PE-XX	VL500060PE(XX)	5" x 5" x 5' 2-Rail End Post (0.135" wall)	DF,WH,TN,DW,CC,WA,CY,SG,DS	60"	54
VL500060PC-XX	VL500060PC(XX)	5" x 5" x 5' 2-Rail Corner Post (0.135" wall)	DF,WH,TN,DW,CC,WA,CY,SG,DS	60"	54
VL500060PT-XX	VL500060PT(XX)	5" x 5" x 5' 2-Rail 3-way (0.135" wall)	DF,WH,TN,DW,CC,WA,CY,SG,DS	60"	54

## 3-Rail PVC Posts

CAD Item #	US Item #	Description	Colour	Height	#/Bag
C.T.O.	VL500078BP(XX)	5" x 5" x 6'6" Blank Post (0.135" wall)	DF,WH,TN,DW,CC,WA,CY,SG,DS	72"	54
VL500078PL-XX	VL500078PL(XX)	5" x 5" x 6'6" 3-Rail Line Post (0.135" wall)	DF,WH,TN,DW,CC,WA,CY,SG,DS	72"	54
VL500078PE-XX	VL500078PE(XX)	5" x 5" x 6'6" 3-Rail End Post (0.135" wall)	DF,WH,TN,DW,CC,WA,CY,SG,DS	72"	54
VL500078PC-XX	VL500078PC(XX)	5" x 5" x 6'6" 3-Rail Corner Post (0.135" wall)	DF,WH,TN,DW,CC,WA,CY,SG,DS	72"	54
VL500078PT-XX	VL500078PT(XX)	5" x 5" x 6'6" 3-Rail 3-way (0.135" wall)	DF,WH,TN,DW,CC,WA,CY,SG,DS	72"	54



2-Rail (Left)  
3-Rail (Right)



## 4-Rail PVC Posts

CAD Item #	US Item #	Description	Colour	Height	#/Bag
C.T.O.	VL504078BP(XX)	5" x 5" x 72" Blank Post (0.135" wall )	DF,WH,TN,DW,CC,WA,CY,SG,DS	72"	54
VL504078PL-XX	VL504078PL(XX)	5" x 5" x 72" 4-Rail Line Post (0.135" wall )	DF,WH,TN,DW,CC,WA,CY,SG,DS	72"	54
VL504078PE-XX	VL504078PE(XX)	5" x 5" x 72" 4-Rail End Post (0.135" wall )	DF,WH,TN,DW,CC,WA,CY,SG,DS	72"	54
VL504078PC-XX	VL504078PC(XX)	5" x 5" x 72" 4-Rail Corner Post (0.135" wall )	DF,WH,TN,DW,CC,WA,CY,SG,DS	72"	54
VL504078PT-XX	VL504078PT(XX)	5" x 5" x 72" 4-Rail 3-way (0.135" wall )	DF,WH,TN,DW,CC,WA,CY,SG,DS	72"	54

## Ranch Rails

CAD Item #	US Item #	Description	Colour	Length	Weight	#/Bag
VL155516RL-XX	VL155516RL(XX)	1.5" x 5.5" x 16' Notched Ranch Rail (0.080" wall)	DF,WH,TN,DW,WA,DS	192"	13.00 lbs	120
C.T.O.	VL500CFT-XX	5" external flat cap	DF,WH,TN,DW,WA,DS			



## Privacy Panels & Gates

CAD Item #	US Item #	Description	Colour	Height	Width
C.T.O.	VL050611PP(XX)	5' h x 6' w Solid Privacy Panel	DF,WA	60"	60"
C.T.O.	VL060611PP(XX)	6' h x 6' w Solid Privacy Panel	DF,WA	72"	72"
C.T.O.	VL050811PP(XX)	5' h x 8' w Solid Privacy Panel	WH,TN,CY,SG,DF,WA	60"	96"
C.T.O.	VL060811PP(XX)	6' h x 8' w Solid Privacy Panel	WH,TN,CY,SG,DF,WA	72"	96"
VLGT0604-XX	VLGT0604(XX)	6' h x 4' w Solid Privacy Single Gate	WH,TN,CY,SG,DF,DW,DA,WA	72"	48"
VLGT0606-XX	VLGT0606(XX)	6' h x 6' w Solid Privacy Single Gate	WH,TN,CY,SG,DF,DW,DA,WA	672"	72"

Panel includes 2-Pocket Rail; 2-U-Channel; 8-T&G Pickets & 1-Steel Rail Insert



Panels (Left)  
Gates (Right)



## Blank Posts (0.135" Wall)

CAD Item #	US Item #	Description	Colour	Height	Weight	#/Bag
VL400060BP-XX	VL400060BP(XX)	4" x 4" x 60" Blank Post	WH,TN	60"		55
VL400066BP-XX	VL400066BP(XX)	4" x 4" x 66" Blank Post	WH,TN	66"		55
C.T.O.	VL400072BP(XX)	4" x 4" x 72" Blank Post	DF,WH,TN,CY,SG	72"	8.10 lbs	55
C.T.O.	VL400096PB(XX)	4" x 4" x 96" Blank Post	DF,WH,TN,CY,SG	96"	10.80 lbs	
C.T.O.	VL500060PB(XX)	5" x 5" x 60" Blank Post	DF,WH,TN,DW,CC,WA,CY,SG,DS	60"	8.60 lbs	54
C.T.O.	VL500072PB(XX)	5" x 5" x 72" Blank Post	DF,WH,TN,DW,CC,WA,CY,SG,DS	72"	9.40 lbs	54
C.T.O.	VL500078PB(XX)	5" x 5" x 78" Blank Post	DF,WH,TN,DW,CC,WA,CY,SG,DS	78"	10.20 lbs	54
C.T.O.	VL500084BP(XX)	5" x 5" x 7' Blank Post (for 5' Fence)	WH,TN,CY,SG	84"		54
C.T.O.	VL500096BP(XX)	5" x 5" x 8' Blank Post (for 6' fence)	WH,TN,CY,SG,DF,DW,DS,WA	96"		54
C.T.O.	VL500084PB(XX)	5" x 5" x 84" Blank Post	DF,WH,TN,DW,CC,WA,CY,SG,DS	84"	11.00 lbs	54
C.T.O.	VL500096PB(XX)	5" x 5" x 96" Blank Post	DF,WH,TN,DW,CC,WA,CY,SG,DS	96"	12.60 lbs	54
C.T.O.	VL500108PB(XX)	5" x 5" x 108" Blank Post	DF,WH,TN,DW,CC,WA,CY,SG,DS	108"	14.20 lbs	54
C.T.O.	VL500120PB(XX)	5" x 5" x 120" Blank Post	DF,WH,TN,DW,CC,WA,CY,SG,DS	120"	15.80 lbs	
C.T.O.	VL500144PB(XX)	5" x 5" x 144" Blank Post	DF,WH,TN,DW,CC,WA,CY,SG,DS	144"	18.95 lbs	

## Privacy Posts

CAD Item #	US Item #	Description	Colour	Height	#/Bag
VL500084PL-XX	VL500084PL(XX)	5" x 5" x 7' Privacy Line Post (for 5' fence)	WH,TN,CY,SG,DF,DW,DS,WA	84"	54
VL500084PE-XX	VL500084PE(XX)	5" x 5" x 7' Privacy End Post (for 5' fence)	WH,TN,CY,SG,DF,DW,DS,WA	84"	54
VL500084PC-XX	VL500084PC(XX)	5" x 5" x 7' Privacy Corner Post (for 5' fence)	WH,TN,CY,SG,DF,DW,DS,WA	84"	54
VL500084PT-XX	C.T.O.	5" x 5" x 7' Privacy 3-Way Post (for 5' fence)	WH,TN,CY,SG	84"	54
VL500096PL-XX	VL500096PL(XX)	5" x 5" x 8' Privacy Line Post (for 6' fence)	WH,TN,CY,SG,DF,DW,DS,WA	96"	54
VL500096PE-XX	VL500096PE(XX)	5" x 5" x 8' Privacy End Post (for 6' fence)	WH,TN,CY,SG,DF,DW,DS,WA	96"	54
VL500096PC-XX	VL500096PC(XX)	5" x 5" x 8' Privacy Corner Post (for 6' fence)	WH,TN,CY,SG,DF,DW,DS,WA	96"	54
VL500096PT-XX	VL500096PT(XX)	5" x 5" x 8' Privacy 3-Way Post (for 6' fence)	WH,TN,CY,SG	96"	54

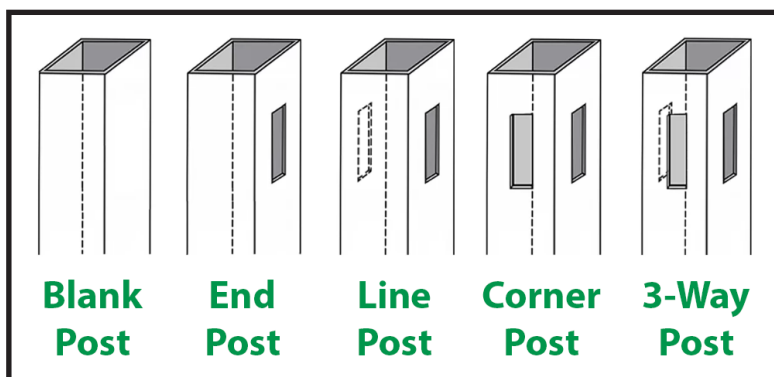

## Privacy Panel Insert

CAD Item #	US Item #	#/Bag
C.T.O.	VLRAILSTEL	1



## Privacy Panel Rails

CAD Item #	US Item #	Description	Colour	Height	#/Bag
VL155571RL-XX	VL155571RL(XX)	1.5" x 5.5" x 71.5" Pocket Rail (.090 wall)	WH,TN,CY,SG,DF,DW,CC,WA,DS	71.5"	112
VL155595RL-XX	VL155595RL(XX)	1 1/2" x 5 1/2" x 95" Rail (.135 wall )	WH,TN,CY,SG,DF,DW,CC,WA,DS	95"	112
C.T.O.	VL178871DR(XX)	1.75" x 8" x 71.5" Deco Pocket Rail	WH,TN,CY,SG,DF,DW,CC,WA,DS	71.5"	
C.T.O.	VL178895DR(XX)	1.75" x 8" x 95" Deco Pocket Rail	WH,TN,CY,SG,DF,DW,CC,WA,DS	95"	



## Gate Hardware

CAD Item #	US Item #	Description	#/Bag
VLPADLATBK	VLPADLATBK	Paddle Latch	20
VLHGNSNBK	VLHGNSNBK	Non Self-Closing Steel Hinge (Narrow to Narrow)	12
VLHGSCSNBK	VLHGSCSNBK	Self-Closing Steel Hinge (Standard to Narrow)	20
GH024DROP	GH024DROP	24" Drop Bolt	15

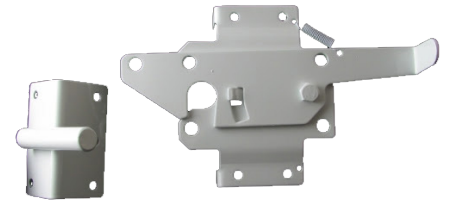

## Vinyl Adhesive

CAD Item #	US Item #	Description	#/Bag	Weight
VL150CRHG	VL150CRHG	1.5oz Tube - Clear Vinyl Adhesive	24	1.5oz
C.T.O.	C.T.O.	5.25oz Tube - Clear Vinyl Adhesive	24	5.25oz
VL800CRHG	C.T.O.	8oz Tube - Christy's Red Hot PVC Glue	24	8oz



## Vinyl Post Anchors & Ties

CAD Item #	US Item #	Description	Colour
VL400PTOW	VL404024UNVB	4" x 4" x 24" Steel Universal Bracket	Galv
VLPOSTTOWR	VL505024UNVB	5" x 5" x 24" Steel Universal Bracket	Galv
VL500TRT	VL500TRT	5" Post Top Rail Tie (TRT)	Red
VLPTLVLCOL	VLPTLVLCOL	Levelling Collar	Red

Post Top Rail Tie

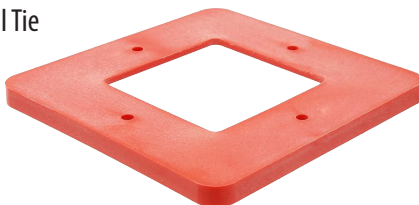

Universal Bracket (Left)  
Levelling Collar (Below)



## Privacy Panel Components & Inserts

CAD Item #	US Item #	Description	Colour/Material	Height	#/Bag
VL781150TG-XX	VL781150TGL(XX)	7/8" x 11.3" x 50 1/4" T&G Picket- (for 5' privacy)	WH,TN,CY,SG	50.25"	137
VL781162TG-XX	VL781162TG(XX)	7/8" x 11.3" x 62 1/4" T&G Picket- (for 6' privacy)	WH,TN,CY,SG	62.25"	137
VL78059UC-WXX	VL78059UC(XX)	.875" x 59" U-Channel	WH,TN,CY,SG,DF,DW,CC,WA,DS		70
C.T.O.	VL60TGU CST	T & G Panel Stiffener 60" U-Channel -Steel	Galvanized Steel	60"	
VLRAILSTEL	VLRAILSTEL	1 1/2" x 5 1/2" x 8' Steel Rail Insert	Galvanized Steel	96"	
VL2358RSTEL	VL2358RSTEL	2" x 3 1/2" x 8' Steel Rail Insert	Galvanized Steel	96"	
VL4408LSTEL	VL4406LSTEL	4" x 4" x 6' Steel Post Insert	Galvanized Steel	72"	
VL5508LSTEL	VL5508LSTEL	5" x 5" x 8' Steel Post Insert	Galvanized Steel	96"	
VL4406HALUM	C.T.O.	4" x 4" x 6' Aluminum H-Style Post inserts	Aluminum	72"	
VL4408HALUM	C.T.O.	4" x 4" x 8' Aluminum H-Style Post inserts	Aluminum	96"	
VL5508HALUM	VL5508HALUM	5" x 5" x 8' Aluminum H-Style Post inserts	Aluminum	96"	

## Tools For Vinyl Fencing

CAD Item #	US Item #	Description
TLVINYLNOT	TLVINYLNOT	Rail Notcher



## Triple 4 Tongue & Groove Picket

CAD Item #	US Item #	Description	Colour	Height	Width	Weight
C.T.O.	VL781138TG(XX)	.875" x 11.3" x 38.25"	WH,TN,CY,SG,DF,DW,CC,WA,DS	38.25"	11.3"	3.75 lbs
C.T.O.	VL781150TG(XX)	.875" x 11.3" x 50.25"	WH,TN,CY,SG,DF,DW,CC,WA,DS	50.25"	11.3"	4.00 lbs
C.T.O.	VL781162TG(XX)	.875" x 11.3" x 62.25"	WH,TN,CY,SG,DF,DW,CC,WA,DS	62.25"	11.3"	4.30 lbs
C.T.O.	VL781192TG(XX)	.875" x 11.3" x 192"	WH,TN,CY,SG,DF,DW,CC,WA,DS	192"	11.3"	13.30 lbs

## Picket Panels

CAD Item #	US Item #	Description	Type	Colour	Height
VL030678PP-XX	VL030678PP(XX)	3' h x 6' w Wide(3") Picket Panel	Wide	WH,TN	36"
VL420678PP-XX	VL420678PP(XX)	42" h x 6' w Wide(3") Picket Panel	Wide	WH,TN	42"
VL040678PP-XX	VL040678PP(XX)	4' h x 6' w Wide(3") Picket Panel	Wide	WH,TN	48"
VL030878PP-XX	VL030878PP(XX)	3' h x 8' w Wide(3") Picket Panel w/Rail Insert	Wide	WH,TN	36"
VL420878PP-XX	VL420878PP(XX)	42" h x 8' w Wide(3") Picket Panel w/Rail Insert	Wide	WH,TN	42"
VL040878PP-XX	VL040878PP(XX)	4' h x 8' w Wide(3") Picket Panel w/Rail Insert	Wide	WH,TN	48"
VL030612PP-XX	VL030612PP(XX)	3' h x 6' w Narrow(1 1/2") Picket Panel	Narrow	WH,TN	36"
VL420612PP-XX	VL420612PP(XX)	42" h x 6' w Narrow(1 1/2") Picket Panel	Narrow	WH,TN	42"
VL040612PP-XX	VL040612PP(XX)	4' h x 6' w Narrow(1 1/2") Picket Panel	Narrow	WH,TN	48"
VL030812PP-XX	VL030812PP(XX)	3' h x 8' w Narrow(1-1/2") Picket Panel w/Rail Insert	Narrow	WH,TN	36"
VL420812PP-XX	VL420812PP(XX)	42" h x 8' w Narrow(1-1/2") Picket Panel w/Rail Insert	Narrow	WH,TN	42"
VL040812PP-XX	VL040812PP(XX)	4' h x 8' w Narrow(1-1/2") Picket Panel w/Rail Insert	Narrow	WH,TN	48"

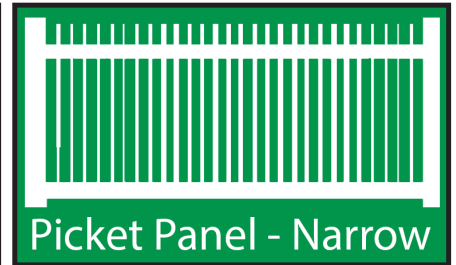
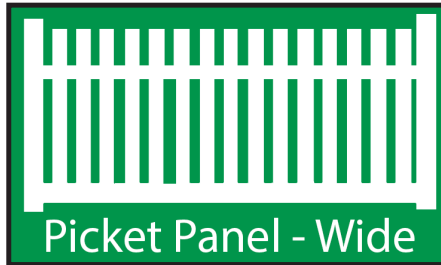

## Semi-Privacy Posts

CAD Item #	US Item #	Description	Type	Colour	Height	#/Bag
VL8405SL-XX	VL8405SL(XX)	5" x 5" x 7' Line Post (for 5' fence)	Line	WH,TN	7'	54
VL8405SE-XX	VL8405SE(XX)	5" x 5" x 7' End Post (for 5' fence)	End	WH,TN	7'	54
VL8405SC-XX	VL8405SC(XX)	5" x 5" x 7' Corner Post (for 5' fence)	Corner	WH,TN	7'	54
VL9605SL-XX	VL9605SL(XX)	5" x 5" x 8' Line Post (for 6' fence)	Line	WH,TN	8'	54
VL9605SE-XX	VL9605SE(XX)	5" x 5" x 8' End Post (for 6' fence)	End	WH,TN	8'	54
VL9605SC-XX	VL9605SC(XX)	5" x 5" x 8' Corner Post (for 6' fence)	Corner	WH,TN	8'	54

## Picket Posts

CAD Item #	US Item #	Description	Type	Colour	Height	#/Pallet
VL400060PL-XX	VL400060PL(XX)	4" x 4" x 5' Line Post (for 3' tall)	Line	WH,TN	60"	55
VL400060PE-XX	VL400060PE(XX)	4" x 4" x 5' End Post (for 3' tall)	End	WH,TN	60"	55
VL400060PC-XX	VL400060PC(XX)	4" x 4" x 5' Corner Post (for 3' tall)	Corner	WH,TN	60"	55
VL400066PL-XX	VL400066PL(XX)	4" x 4" x 5'6" Line Post (for 42" tall)	Line	WH,TN	66"	55
VL400066PE-XX	VL400066PE(XX)	4" x 4" x 5'6" End Post (for 42" tall)	End	WH,TN	66"	55
VL400066PC-XX	VL400066PC(XX)	4" x 4" x 5'6" Corner Post (for 42" tall)	Corner	WH,TN	66"	55
VL400072PL-XX	VL400072PL(XX)	4" x 4" x 6' Line Post (for 4' tall)	Line	WH,TN	72"	55
VL400072PE-XX	VL400072PE(XX)	4" x 4" x 6' End Post (for 4' tall)	End	WH,TN	72"	55
VL400072PC-XX	VL400072PC(XX)	4" x 4" x 6' Corner Post (for 4' tall)	Corner	WH,TN	72"	55

## Scallop Picket Posts

CAD Item #	US Item #	Description	Type	Colour	Height	#/Pallet
VL400060SL-XX	VL400060SL(XX)	4" x 4" x 5' Scallop Picket Line Post (for 3' tall)	Line	WH,TN	60"	55
VL400060SE-XX	VL400060SE(XX)	4" x 4" x 5' Scallop Picket End Post (for 3' tall)	End	WH,TN	60"	55
VL400060SC-XX	VL400060SC(XX)	4" x 4" x 5' Scallop Picket Corner Post (for 3' tall)	Corner	WH,TN	60"	55
VL400066SL-XX	VL400066SL(XX)	4" x 4" x 5'6" Scallop Picket Line Post (for 42" tall)	Line	WH,TN	66"	55
VL400066SE-XX	VL400066SE(XX)	4" x 4" x 5'6" Scallop Picket End Post (for 42" tall)	End	WH,TN	66"	55
VL400066SC-XX	VL400066SC(XX)	4" x 4" x 5'6" Scallop Picket Corner Post (for 42" tall)	Corner	WH,TN	66"	55
VL400072SL-XX	VL400072SL(XX)	4" x 4" x 6' Scallop Picket Line Post (for 4' tall)	Line	WH,TN	72"	55
VL400072SE-XX	VL400072SE(XX)	4" x 4" x 6' Scallop Picket End Post (for 4' tall)	End	WH,TN	72"	55
VL400072SC-XX	VL400072SC(XX)	4" x 4" x 6' Scallop Picket Corner Post (for 4' tall)	Corner	WH,TN	72"	55

## Semi-Privacy Picket Panel

CAD Item #	US Item #	Description	Type	Colour	Height
VL050878SP-XX	VL050878SP(XX)	5' h x 8' w Semi Privacy Panel (7/8" x 3" Picket)	Wide	WH,TN	60"
VL060878SP-XX	VL060878SP(XX)	6' h x 8' w Semi Privacy Panel (7/8" x 3" Picket)	Wide	WH,TN	72"
VL050812SP-XX	VL050812SP(XX)	5' h x 8' w Semi Privacy Panel (7/8" x 1-1/2" Picket)	Narrow	WH,TN	60"
VL060812SP-XX	VL060812SP(XX)	6' h x 8' w Semi Privacy Panel (7/8" x 1-1/2" Picket)	Narrow	WH,TN	72"
VL050816SP-XX	VL050816SP(XX)	5' h x 8' Semi Privacy Alternate 3" & 1-1/2" Picket Panel	Alternating	WH,TN	60"
VL060816SP-XX	VL060816SP(XX)	6' h x 8' Semi Privacy Alternate 3" & 1-1/2" Picket Panel	Alternating	WH,TN	72"



## Scallop Picket Panels

CAD Item #	US Item #	Description	Type	Colour	Height
VL030678PS-XX	VL030678PS(XX)	3' h x 6' w Scallop Wide(3") Picket Panel	Wide	WH,TN	36"
VL420678PS-XX	VL420678PS(XX)	42" h x 6' w Scallop Wide(3") Picket Panel	Wide	WH,TN	42"
VL040678PS-XX	VL040678PS(XX)	4' h x 6' w Scallop Wide(3") Picket Panel - White	Wide	WH,TN	48"
VL030878PS-XX	VL030878PS(XX)	3' h x 8' w Scallop Wide(3") Picket Panel w/Rail Insert	Wide	WH,TN	36"
VL420878PS-XX	VL420878PS(XX)	42" h x 8' w Scallop Wide(3") Picket Panel w/Rail Insert	Wide	WH,TN	42"
VL040878PS-XX	VL040878PS(XX)	4' h x 8' w Scallop Wide(3") Picket Panel w/Rail Insert	Wide	WH,TN	48"
VL030612PS-XX	VL030612PS(XX)	3' h x 6' w Scallop Narrow(1-1/2") Picket Panel	Narrow	WH,TN	36"
VL420612PS-XX	VL420612PS(XX)	42" h x 6' w Scallop Narrow(1-1/2") Picket Panel	Narrow	WH,TN	42"
VL040612PS-XX	VL040612PS(XX)	42" h x 6' w Scallop Narrow(1-1/2") Picket Panel	Narrow	WH,TN	48"
VL030812PS-XX	VL030812PS(XX)	3' h x 8' w Scallop Narrow (1-1/2") Picket Panel w/Rail Insert	Narrow	WH,TN	36"
VL420812PS-XX	VL420812PS(XX)	42" h x 8' w Scallop Narrow (1-1/2") Picket Panel w/Rail Insert	Narrow	WH,TN	42"
VL040812PS-XX	VL040812PS(XX)	4' h x 8' w Scallop Narrow (1-1/2") Picket Panel w/Rail Insert	Narrow	WH,TN	48"

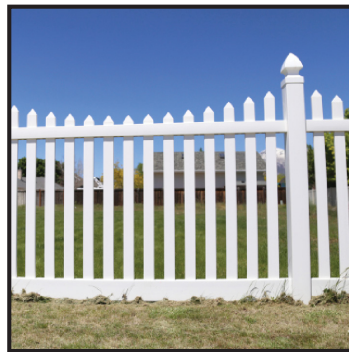

Wide (Left)  
Narrow (Right)



## Arched Picket Posts

CAD Item #	US Item #	Description	Type	Colour	Height
VL400060AL-XX	VL400060AL(XX)	4" x 4" x 5' Arched Picket Line Post (for 3' tall)	Line	WH,TN	60"
VL400060AE-XX	VL400060AE(XX)	4" x 4" x 5' Arched Picket End Post (for 3' tall)	End	WH,TN	60"
VL400060AC-XX	VL400060AC(XX)	4" x 4" x 5' Arched Picket Corner Post (for 3' tall)	Corner	WH,TN	60"
VL400066AL-XX	VL400066AL(XX)	4" x 4" x 5'6" Arched Picket Line Post (for 42" tall)	Line	WH,TN	66"
VL400066AE-XX	VL400066AE(XX)	4" x 4" x 5'6" Arched Picket End Post (for 42" tall)	End	WH,TN	66"
VL400066AC-XX	VL400066AC(XX)	4" x 4" x 5'6" Arched Picket Corner Post (for 42" tall)	Corner	WH,TN	66"
VL400072AL-XX	VL400072AL(XX)	4" x 4" x 6' Arched Picket Line Post (for 4' tall)	Line	WH,TN	72"
VL400072AE-XX	VL400072AE(XX)	4" x 4" x 6' Arched Picket End Post (for 4' tall)	End	WH,TN	72"
VL400072AC-XX	VL400072AC(XX)	4" x 4" x 6' Arched Picket Corner Post (for 4' tall)	Corner	WH,TN	72"

## Arched Picket Panels

CAD Item #	US Item #	Description	Type	Colour	Height
VL030678PA-XX	VL030678PA(XX)	36" h x 6' w Arched Wide(3") Picket Panel	Wide	WH,TN	36"
VL420678PA-XX	VL420678PA(XX)	42" h x 6' w Arched Wide(3") Picket Panel	Wide	WH,TN	42"
VL040678PA-XX	VL040678PA(XX)	48" h x 6' w Arched Wide(3") Picket Panel	Wide	WH,TN	48"
VL030878PA-XX	VL030878PA(XX)	36" h x 8' w Arched Wide(3") Picket Panel w/Rail Insert	Wide	WH,TN	36"
VL420878PA-XX	VL420878PA(XX)	42" h x 8' w Arched Wide(3") Picket Panel w/Rail Insert	Wide	WH,TN	42"
VL040878PA-XX	VL040878PA(XX)	48" h x 8' w Arched Wide(3") Picket Panel w/Rail Insert	Wide	WH,TN	48"
VL030612PA-XX	VL030612PA(XX)	36" h x 6' w Arched Narrow(1-1/2") Picket Panel	Narrow	WH,TN	36"
VL420612PA-XX	VL420612PA(XX)	42" h x 6' w Arched Narrow(1-1/2") Picket Panel	Narrow	WH,TN	42"
VL040612PA-XX	VL040612PA(XX)	48" h x 6' w Arched Narrow(1-1/2") Picket Panel	Narrow	WH,TN	48"
VL030812PA-XX	VL030812PA(XX)	36" h x 8' w Arched Narrow(1-1/2") Picket Panel w/Rail Insert	Narrow	WH,TN	36"
VL420812PA-XX	VL420812PA(XX)	42" h x 8' w Arched Narrow(1-1/2") Picket Panel w/Rail Insert	Narrow	WH,TN	42"
VL040812PA-XX	VL040812PA(XX)	48" h x 8' w Arched Narrow(1-1/2") Picket Panel w/Rail Insert	Narrow	WH,TN	48"

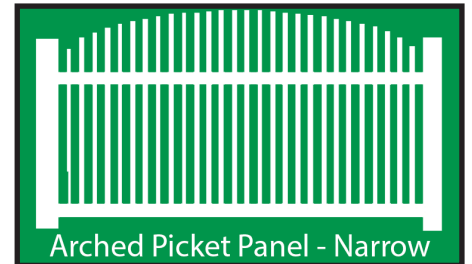
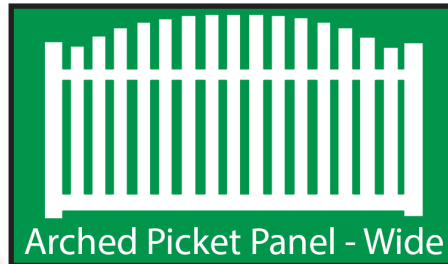

## Flat Top Picket Panels

CAD Item #	US Item #	Description	Type	Colour	Height
VL030678FT-XX	VL030678FT(XX)	36" h x 6' w Flat Top Wide(3") Picket Panel	Wide	WH,TN	36"
VL420678FT-XX	VL420678FT(XX)	42" h x 6' w Flat Top Wide(3") Picket Panel	Wide	WH,TN	42"
VL040678FT-XX	VL040678FT(XX)	4' h x 6' w Flat Top Wide(3") Picket Panel	Wide	WH,TN	48"
VL030878FT-XX	VL030878FT(XX)	36" h x 8' w Flat Top Wide(3") Picket Panel w/Rail Insert	Wide	WH,TN	36"
VL420878FT-XX	VL420878FT(XX)	42" h x 8' w Flat Top Wide(3") Picket Panel w/Rail Insert	Wide	WH,TN	42"
VL040878FT-XX	VL040878FT(XX)	4' h x 8' w Flat Top Wide(3") Picket Panel w/Rail Insert	Wide	WH,TN	48"
VL030612FT-XX	VL030612FT(XX)	36" h x 6' w Flat Top Narrow (1-1/2") Picket Panel	Narrow	WH,TN	36"
VL420612FT-XX	VL420612FT(XX)	42" h x 6' w Flat Top Narrow (1-1/2") Picket Panel	Narrow	WH,TN	42"
VL040612FT-XX	VL040612FT(XX)	4' h x 6' w Flat Top Narrow (1-1/2") Picket Panel	Narrow	WH,TN	48"
VL030812FT-XX	VL030812FT(XX)	36" h x 8' w Flat Top Narrow (1-1/2") Picket Panel w/Rail Insert	Narrow	WH,TN	36"
VL420812FT-XX	VL420812FT(XX)	42" h x 8' w Flat Top Narrow (1-1/2") Picket Panel w/Rail Insert	Narrow	WH,TN	42"
VL040812FT-XX	VL040812FT(XX)	4' h x 8' w Flat Top Narrow (1-1/2") Picket Panel w/Rail Insert	Narrow	WH,TN	48"

## Flat Top Picket Posts

CAD Item #	US Item #	Description	Type	Colour	#/Box
VL400060FL-XX	VL400060FL(XX)	4" x 4" x 5' Flat Top Picket Line Post (for 3' tall)	Line	WH,TN	55
VL400060FE-XX	VL400060FE(XX)	4" x 4" x 5' Flat Top Picket End Post (for 3' tall)	End	WH,TN	55
VL400060FC-XX	VL400060FC(XX)	4" x 4" x 5' Flat Top Picket Corner Post (for 3' tall)	Corner	WH,TN	55
VL400066FL-XX	VL400066FL(XX)	4" x 4" x 5'6" Flat Top Picket Line Post (for 42" tall)	Line	WH,TN	55
VL400066FE-XX	VL400066FE(XX)	4" x 4" x 5'6" Flat Top Picket End Post (for 42" tall)	End	WH,TN	55
VL400066FC-XX	VL400066FC(XX)	4" x 4" x 5'6" Flat Top Picket Corner Post (for 42" tall)	Corner	WH,TN	55
VL400072FL-XX	VL400072FL(XX)	4" x 4" x 6' Flat Top Picket Line Post (for 4' tall)	Line	WH,TN	55
VL400072FE-XX	VL400072FE(XX)	4" x 4" x 6' Flat Top Picket End Post (for 4' tall)	End	WH,TN	55
VL400072FC-XX	VL400072FC(XX)	4" x 4" x 6' Flat Top Picket Corner Post (for 4' tall)	Corner	WH,TN	55



## Hollow Rail

CAD Item #	US Item #	Description	Colour	Height	Weight
C.T.O.	VL235072RL(XX)	2" x 3.5" x 72" Hollow Rail	DF,WH,TN,CY,SG	72"	4.20 lbs
C.T.O.	VL235096RL(XX)	2" x 3.5" x 96" Hollow Rail	DF,WH,TN,CY,SG	96"	5.50 lbs
C.T.O.	VL235144RL(XX)	2" x 3.5" x 144" Hollow Rail	DF,WH,TN,CY,SG	144"	9.65 lbs

## Pickets

CAD Item #	US Item #	Description	Colour	Height	Weight	#/Box
C.T.O.	VL781216PK(XX)	.875" x 1-1/2" x 192" Pickets	DF,WH,TN,CY,SG	192"	2.80 lbs	
C.T.O.	VL783192PK(XX)	.875" x 3" x 192" Pickets	DF,WH,TN,CY,SG	192"	4.00 lbs	
C.T.O.	VL786144PK(XX)	.875" x 6" x 144" Pickets	DF,WH,TN,CY,SG	144"	6.00 lbs	
C.T.O.	VL786192PK(XX)	.875" x 6" x 192" Pickets	DF,WH,TN,CY,SG	192"	8.00 lbs	
VL781216PK -XX	VL781216PK(XX)	7/8" x 1 1/2" x 192" Picket (.110" wall)	WH,TN	192"		112, 280
VL783192PK -XX	VL783192PK(XX)	7/8" x 3" x 192" Picket (.110" wall)	WH,TN	192"		112, 156

## Post Caps

CAD Item #	US Item #	Description	Type	Colour	#/Box
VL400CFT-XX	VL400CFT(XX)	4" External Flat Cap	External Flat	WH,TN	50
VL400CGO-XX	VL400CGO(XX)	4" Gothic Post Cap	Gothic	WH,TN	50
VL400CBL-XX	VL400CBL(XX)	4" Ball Post Cap	Ball Post	WH,TN	50
VL500CFT-XX	VL500CFT(XX)	5" External Flat Cap	External Flat	WH,TN,DF,DW	50
VL500CGO-XX	VL500CGO(XX)	5" Gothic Post Cap	Gothic	WH,TN	50
VL500CBL-XX	VL500CBL(XX)	5" Ball Post Cap	Ball Post	WH,TN	50



## Picket Caps

CAD Item #	US Item #	Description	Colour	Width	#/Box
VL78112CDE-XX	VL78112CDE(XX)	7/8" x 1-1/2" Dog Eared	WH,TN	1.5"	50
VL78300CDE-XX	VL78300CDE(XX)	7/8" x 3" Dog Eared (Locking)	WH,TN	3"	50
VL78112CSP-XX	VL78112CSP(XX)	7/8" x 1-1/2" Pointed	WH,TN	1.5"	50
VL78112CSP-XX	VL78300CSP(XX)	7/8" x 3" Pointed (Locking)	WH,TN	3"	50

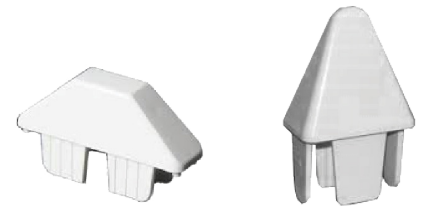

## Rail Caps

CAD Item #	US Item #	Description	Colour	Width	Weight	#/Box
VL2312EC-XX	VL2312ECXX	2" x 3 1/2" End Rail Cap	WH,TN	3.5"	2.80 lbs	
VL1555EC-XX	VL1555ECXX	1 1/2" x 5 1/2" End Rail Cap	WH,TN	5.5"	4.00 lbs	
VLSNAPCP-XX	VLSNAPCPXX	Snap Cap	WH,TN		6.00 lbs	1000



End Rail Cap (Left)  
Snap Cap (Right)



# PRO LINK SUPPLY

## Wood

---



## Cedar Split Rail Posts

CAD Item #	US Item #	Description	Type	Height	Weight
9220	WOSR002RLIN	5'4" 2 Rail Line Post (18")	Line	64"	23.00 lbs
9222	WOSR002REND	5'4" 2 Rail End Post (18")	End	64"	23.00 lbs
9224	WOSR002RCOR	5'4" 2 Rail Corner Post (18")	Corner	64"	25.00 lbs
9230	WOSR003RLIN	6'6" 3 Rail Line Post (18")	Line	78"	29.00 lbs
9232	WOSR003REND	6'6" 3 Rail End Post (18")	End	78"	29.00 lbs
9234	WOSR003RCOR	6'6" 3 Rail Corner Post (18")	Corner	78"	29.00 lbs
C.T.O.	WOSR003RBLK	6'6" 3 Rail Blank Post (18")	Blank	78"	29.00 lbs



2-Rail

## Cedar Split Rails

CAD Item #	US Item #	Description	Type	Length	Weight
9200	WOSR008RAIL	8' Standard Rail (12-14")	Standard	96"	16.00 lbs
9202	WOSR010RAIL	10' Standard Rail (12-14")	Standard	120"	20.00 lbs
9210	WOSR010JUMB	10' Jumbo Rail (14-16")	Jumbo	120"	24.00 lbs
C.T.O.	WOSR010BLNK	10' Blank Rail (12-14")	Blank	120"	20.00 lbs

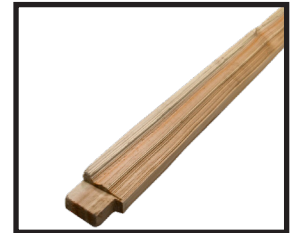

## Cedar Split Rail Gates & Hardware

CAD Item #	US Item #	Description	Type	Height	Weight
C.T.O.	WOSR242GATE	2 Rail x 42" Gate	2-Rail	42"	59.00 lbs
C.T.O.	WOSR260GATE	2 Rail x 60" Gate	2-Rail	60"	87.00 lbs
C.T.O.	WOSR342GATE	3 Rail x 42" Gate	3-Rail	42"	78.00 lbs
C.T.O.	WOSR360GATE	3 Rail x 60" Gate	3-Rail	60"	111.00 lbs
C.T.O.	WOSR034GAHI	3/4" dia. Gate Hinge	3/4"	3/4"	3.00 lbs
C.T.O.	WOSR058GAHI	5/8" dia. Gate Hinge	5/8"	5/8"	3.40 lbs
C.T.O.	WOSRLOADBL	Load Bearing Hatch	Hatch		6.90 lbs

## 2x4 Boards

CAD Item #	US Item #	Description	Type	Width	Weight
C.T.O.	WO248ROUG	2" x 4" x 8' Cedar Board - Rough	Rough	96"	11.00 lbs
C.T.O.	WO2410ROUG	2" x 4" x 10' Cedar Board - Rough	Rough	120"	13.75 lbs
C.T.O.	WO248SMTH	2" x 4" x 8' Cedar Board - Smooth	Smooth	96"	10.00 lbs



## ProPost Steel Posts

CAD Item #	US Item #	Description	Type	Height
C.T.O.	PFP096BLK	96' Black ProPost	Black	96"
C.T.O.	PFP096GALV	96" Galvanized ProPost	Galv	96"
C.T.O.	PFP108BLK	108" Black ProPost	Black	108"
C.T.O.	PFP108GALV	108" Galvanized ProPost	Galv	108"
C.T.O.	PFP120GALV	108" Galvanized ProPost	Galv	120"

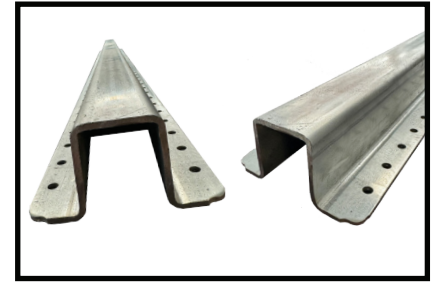

## Pressure Treated Posts

CAD Item #	US Item #	Description	Width	Weight
C.T.O.	W04188POST	4 1/8" x 4 1/8" x 8' Pressure Treated Post	96"	55.00 lbs
C.T.O.	W04189POST	4 1/8" x 4 1/8" x 9' Pressure Treated Post	120"	62.00 lbs

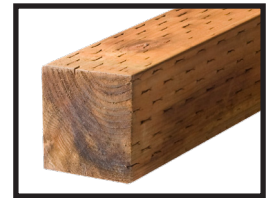

## Round Wood Posts - Blunt or Pointed

CAD Item #	US Item #	Description	Height	Length	Weight	#/Bundle
C.T.O.	W04507POST	4-5" Diameter x 7'	84"	4-5"	56.00 lbs	80
C.T.O.	W04508POST	4-5" Diameter x 8'	96"	4-5"	64.00 lbs	70
C.T.O.	W05607POST	5-6" Diameter x 7'	84"	5-6"	56.00 lbs	50
C.T.O.	W05608POST	5-6" Diameter x 8'	96"	5-6"	64.00 lbs	50
C.T.O.	W06707POST	6-7" Diameter x 7'	84"	6-7"	80.00 lbs	35
C.T.O.	W06708POST	6-7" Diameter x 8'	96"	6-7"	91.00 lbs	35
C.T.O.	W07807POST	7-8" Diameter x 7'	84"	7-8"	76.00 lbs	35



## Wood Hinges

CAD Item #	US Item #	Description	Length	Weight	#/Bundle
C.T.O.	FW005HDZC	5" Flat Wood Hinges - Zinc	5"	1.65 lbs	12
C.T.O.	FW006HDZC	6" Flat Wood Hinges - Zinc	6"	1.79 lbs	12
C.T.O.	FW008THBK	8" Ornamental T-Hinge - Black	8"	2.51 lbs	20
C.T.O.	GH008THHD	8" Traditional T-Hinge - Black HD	8"	2.75 lbs	20
C.T.O.	GH008THHC	8" Contemporary T-Hinge - Black HD	8"	2.75 lbs	15
C.T.O.	FG858STRP	8" x 5/8" Strap Hinge - Galvanized	8"	0.80 lbs	50
C.T.O.	FWWDPSTHG	Male Wood Post Hinge - Zinc		0.75 lbs	100

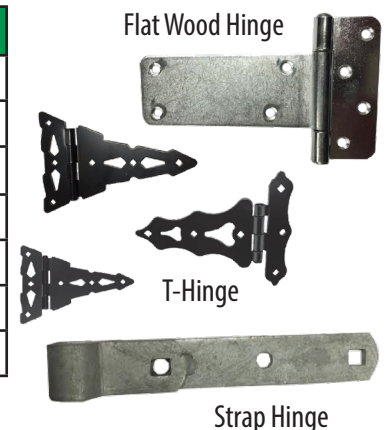

Male Wood Post Hinge

## Post Cap

CAD Item #	US Item #	Description	Weight	#/Bag
C.T.O.	W00206CEDPC	2" x 6" x 6" Cedar Post Cap	2.30 lbs	42



## 2x4 Bracket

CAD Item #	US Item #	Description	Weight	#/Bag
C.T.O.	FW2040BRKT	Wood Bracket 2" x 4"	0.10 lbs	200

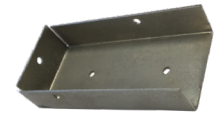

## Latches

CAD Item #	US Item #	Description	Colour	Weight
C.T.O.	FWUNIVZINC	Universal Gate Latch - Zinc		0.50 lbs
C.T.O.	FWUNIVBLCK	Universal Gate Latch - Black	Black	0.50 lbs
C.T.O.	FWSLIDEBLK	Slide Action Latch - Black	Black	0.70 lbs
C.T.O.	GHGRAVIHD	Gravity Latch - Heavy Duty		1.40 lbs
C.T.O.	FW008GLHD	Gravity Latch HD w/Cable & O-ring		1.45 lbs
C.T.O.	FWGATEFL	Wood Post Fork Latch - Black	Black	2.00 lbs
C.T.O.	FWSTANDPLBK	Standard Post Latch - Black	Black	2.00 lbs
C.T.O.	GHPOSTSTAN	Post Latch - Black	Black	2.55 lbs
C.T.O.	GHPOSTCONT	Post Latch Contemporary - Black	Black	2.00 lbs
C.T.O.	FW008TLBK	8" Ornamental Thumb Latch - Black	Black	2.41 lbs

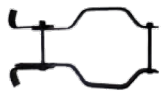
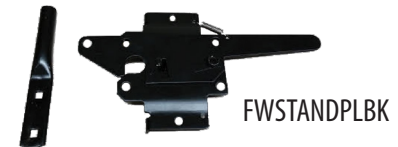

Fork Latch (Left)  
Grav Latch (Right)



## Lokk Bolt

CAD Item #	US Item #	Description	Weight	#/Bag
C.T.O.	GH24LKBLB	24" Lokk Bolt - Black	2.70 lbs	10



## Deluxe Cane Bolt Assembly

CAD Item #	US Item #	Description	Height	Weight	#/Box
C.T.O.	FW1858CBBLK	18" Standard (5/8" dia) Cane Bolt - Black	18"	2.20 lbs	12
05082-PS	FW2458CBBLK	24" Standard (5/8" dia) Cane Bolt - Black	24"	2.60 lbs	10
C.T.O.	FW4858CBBLK	48" Standard (5/8" dia) Cane Bolt - Black	48"	4.62 lbs	10

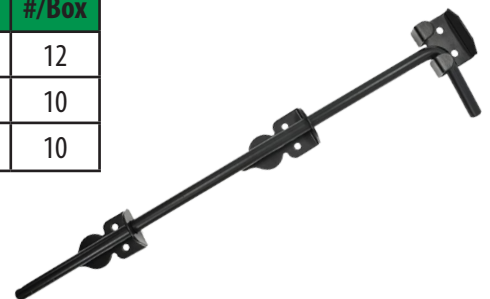

## Wood-To-Steel Brackets

CAD Item #	US Item #	Description	Length	Weight	#/Box
C.T.O.	FW178AWRB	1 7/8" Adjustable Wood Rail Bracket	1 7/8"	0.75 lbs	50
C.T.O.	FW238AWRB	2 3/8" Adjustable Wood Rail Bracket	2 3/8"	0.75 lbs	50
C.T.O.	FW238WRB RB	2 3/8" Fixed Wood Rail Bracket	2 3/8"	0.75 lbs	50
C.T.O.	FW278WRB	2 7/8" Fixed Wood Rail Bracket	2 7/8"	0.75 lbs	50
C.T.O.	FW178CWRB	1 7/8" Corner Wood Rail Bracket	1 7/8"	1.50 lbs	25
C.T.O.	FW238CWRB	2 3/8" Corner Wood Rail Bracket	2 3/8"	1.50 lbs	25
C.T.O.	FWLEFTCWRB	2 3/8" End Clamp Wood Rail Bracket - Left	2 3/8"	1.00 lbs	50
C.T.O.	FWRGHTCWRB	2 3/8" End Clamp Wood Rail Bracket - Right	2 3/8"	1.00 lbs	50
C.T.O.	FW238GNB	2 3/8" Good Neighbor Bracket	2 3/8"	1.71 lbs	25
C.T.O.	FG238WSA	2 3/8" Wood Steel Adaptor	2 3/8"	2.55 lbs	50



Adjustable (Top)  
Fixed (Bottom)



End (Top)  
Corner (Bottom)

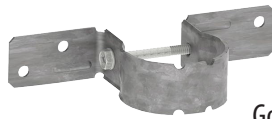
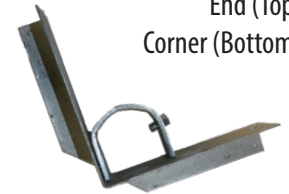

Adaptor (Left)  
Good Neighbor (Right)

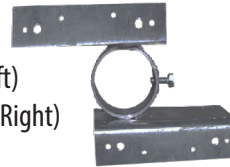

## Gate Spring

CAD Item #	US Item #	Description	Length	Weight	#/Box
C.T.O.	FW013GSBK	13" Gate Spring - Black	13"	1.25 lbs	6



## Drop Rod

CAD Item #	US Item #	Description	Length	Weight	#/Box
C.T.O.	GH024DROP	24" Drop Rod - Black	24"	3.25 lbs	10



# PRO LINK SUPPLY

## Other Accessories



## Hog Rings

CAD Item #	US Item #	Description	Colour	Length	Weight	#/lb	#/Box
C.T.O.	FG1212HOGS	12 1/2 ga Hog Rings - Steel		1 7/8"	25.00 lbs	224	5600
C.T.O.	FG009HOGS	9 ga Hog Rings - Steel		2 3/8"	25.00 lbs	84	2100
C.T.O.	FG011HOGS	11 ga Hog Rings - Steel		2 3/8"	5.00 lbs	130	650
06030-AL	FG009HOGA	9 ga Hog Rings - Aluminum		2 7/8"	10.00 lbs	264	260, 2640
06030-BL	FBK009HOGS	9 ga Hog Rings - Steel (Black)	Black	1 7/8"	25.00 lbs	182	220, 4500
C.T.O.	FBN009HOGS	9 ga Hog Rings - Steel (Brown)	Brown	2 3/8"	25.00 lbs	182	4500
C.T.O.	FGN009HOGS	9 ga Hog Rings - Steel (Green)	Green	2 3/8"	25.00 lbs	182	4500



## Straight Steel Ties

CAD Item #	US Item #	Description	Weight
C.T.O.	FG0712STIE	7" 12 ga Straight Steel Ties	50.00 lbs



## Easy Twist Ties (1.2 oz)

CAD Item #	US Item #	Description	Gauge	Length	Weight	#/Box
C.T.O.	FG15811ETTGA	1 5/8" 11 ga Easy Twist Ties - Galv.	11	1 5/8"	0.02 lbs	1000
C.T.O.	FG21211ETTGA	2 3/8" 11 ga Easy Twist Ties - Galv.	11	2 3/8"	0.02 lbs	1000
C.T.O.	FG13819ETTGA	1 3/8" 9 ga Easy Twist Ties - Galv.	9	1 3/8"	0.02 lbs	1000
C.T.O.	FG15819ETTGA	1 5/8" 9 ga Easy Twist Ties - Galv.	9	1 5/8"	0.02 lbs	1000
C.T.O.	FG20019ETTGA	1 7/8" 9 ga Easy Twist Ties - Galv.	9	1 7/8"	0.02 lbs	1000
C.T.O.	FG21219ETTGA	2 3/8" 9 ga Easy Twist Ties - Galv.	9	2 3/8"	0.02 lbs	1000
C.T.O.	FG30019ETTGA	2 7/8" 9 ga Easy Twist Ties - Galv.	9	2 7/8"	0.02 lbs	500
C.T.O.	FG31219ETTGA	3 1/2" 9 ga Easy Twist Ties - Galv.	9	3 1/2"	0.02 lbs	500
C.T.O.	FG40019ETTGA	4" 9 ga Easy Twist Ties - Galv.	9	4"	0.02 lbs	500
C.T.O.	FBK1389ETTVC	1 3/8" (9ga) Easy Twist Ties - Vinyl Coated (Black)	9	1 3/8"	0.02 lbs	500
C.T.O.	FBK1589ETTVC	1 5/8" (9ga) Easy Twist Ties - Vinyl Coated (Black)	9	1 5/8"	0.02 lbs	500
C.T.O.	FBK1789ETTVC	1 7/8" (9ga) Easy Twist Ties - Vinyl Coated (Black)	9	1 7/8"	0.02 lbs	500
C.T.O.	FBK2389ETTVC	2 3/8" (9ga) Easy Twist Ties - Vinyl Coated (Black)	9	2 3/8"	0.03 lbs	500
C.T.O.	FBK2789ETTVC	2 7/8" (9ga) Easy Twist Ties - Vinyl Coated (Black)	9	2 7/8"	0.04 lbs	500
C.T.O.	FBK4009ETTVC	4" (9ga) Easy Twist Ties - Vinyl Coated (Black)	9	4"	0.05 lbs	500



## Hooked Ties

CAD Item #	US Item #	Description	Gauge	Colour	Length	Weight	#/Box	#/Pallet
06000-PS	FG1512TIES	6 1/2" - 12 ga Steel	12	Steel	6 1/2"	0.02 lbs	100	3000, 2000
06002-PS	C.T.O.	7 1/2" - 12 ga Steel	12	Steel	7 1/2"	0.02 lbs	100	2000
	FG2312TIES	8 1/2" - 12 ga Steel	12	Steel	8 1/2"	0.024 lbs	100	2000
	FG1511TIES	6 1/2" - 11 ga Steel	11	Steel	6 1/2"	0.03 lbs	100	2000
	FG2311TIES	8 1/2" - 11 ga Steel	11	Steel	8 1/2"	0.033 lbs	100	2000
	FG1509TIES	6 1/2" - 9 ga Steel	9	Steel	6 1/2"	0.034 lbs	100	1000
	FG2309TIES	8 1/2" - 9 ga Steel	9	Steel	8 1/2"	0.043 lbs	100	1000
06000-AL	FG1709TIEAL	6 1/2" - 9 ga Aluminum	9	Steel	6 1/2"	0.014 lbs	100	3700
06002-AL	C.T.O.	7 1/2" - 9 ga Aluminum	9	Aluminum	7 1/2"	0.016 lbs	100	2000
	FG2309TIEAL	8 1/4" - 9 ga Aluminum	9	Aluminum	8 1/2"	0.018 lbs	100	3100
06004-AL	C.T.O.	8 1/2" - 9 ga Aluminum	9	Aluminum	8 1/2"	0.018 lbs	100	2000
	FG2709TIEAL	9 1/4" - 9 ga Aluminum	9	Aluminum	9 1/4"	0.02 lbs	100	3000, 2600
06006-AL	C.T.O.	10 1/2" - 9 ga Aluminum	9	Aluminum	10 1/2"	0.02 lbs	101	2000
	FG1209TIEAL	12" - 9 ga. Aluminum	9	Aluminum	12"	0.03 lbs	100	2500
06000-BL	FBK1509TIES	6 1/2" - 9 ga Steel (Black)	9	Black	6 1/2"	0.04 lbs	100	2000
	FBN1509TIES	6 1/2" - 9 ga Steel (Brown)	9	Brown	6 1/2"	0.04 lbs	100	2000
	FBK2309TIES	8 1/2" - 9 ga Steel (Black)	9	Black	8 1/2"	0.05 lbs	100	1000
	FBN2309TIES	8 1/2" - 9 ga Steel (Brown)	9	Brown	8 1/2"	0.05 lbs	100	1000
	FBK1709TIEAL	6 1/2" - 9 ga Aluminum (Black)	9	Black	6 1/2"	0.02 lbs	100	2400
	FGN1709TIEAL	6 1/2" - 9 ga Aluminum (Green)	9	Green	6 1/2"	0.02 lbs	100	2400
06002-BL	C.T.O.	7 1/2" - 9 ga Aluminum (Black)	9	Black	7 1/2"	0.02 lbs	100	2000
06004-BL	FBK2309TIEAL	8 1/2" - 9 ga Aluminum (Black)	9	Black	8 1/2"	0.02 lbs	100	2000, 1700
	FGN2309TIEAL	8 1/2" - 9 ga Aluminum (Green)	9	Green	8 1/2"	0.02 lbs	100	1700



## Turnbuckle

CAD Item #	US Item #	Description	Weight	#/Box
C.T.O.	FG386TRNI	3/8" x 6" Turnbuckle w/Galv Iron Body-Eye to Eye	0.76 lbs	50



## Round Flanges

CAD Item #	US Item #	Description	Length	Weight	#/Box
C.T.O.	FG1712RFLN	1 7/8" Round Flange	1 7/8"	0.55 lbs	50
C.T.O.	FG2312RFLN	2 3/8" Round Flange	2 3/8"	0.80 lbs	50



## Aerosol Spray Cans

CAD Item #	US Item #	Description	Colour	Weight	#/Box
06294-BZ	PABRITE	12.5 oz Bright Zinc	Bright Zinc	1.00 lbs	12
C.T.O.	PABLACK	12 oz Black Pearl Spray Paint	Black Pearl	1.00 lbs	12
C.T.O.	PABROWN	12 oz Fence Brown Spray Paint	Brown	1.00 lbs	12
C.T.O.	PAGREEN	12 oz New Fence Green Spray Paint	Green	1.00 lbs	12
06296-BL	C.T.O.	16 Oz. Cold Galvanized Spray Paint - Black	Black	1.00 lbs	



## Cement Products

CAD Item #	US Item #	Description	Type	Weight	#/Box
C.T.O.	CM060CON	Concrete Mix - 60 lb Bag	Standard	60.00 lbs	56
C.T.O.	CMPORTLAND	Portland Cement - 94 lb Bag	Portland	94.00 lbs	35
C.T.O.	CMREADYSET	Readysset - 50 lb Pail	Readysset	50.00 lbs	36
C.T.O.	CMQUICKSET	Quickset - 50 lb Bag	Quickset	50.00 lbs	56
C.T.O.	CMQUIKR	Quik-Rok	Quik-Rok	52.50 lbs	27

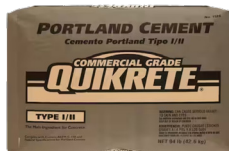

## Safety Top Cap

CAD Item #	US Item #	Description	Length	Weight
C.T.O.	SL400TCLY	Safety Top Cap - LITE (80'/bag) - Yellow	80'	25.00 lb
C.T.O.	SL400TCYW	Safety Top Cap (40'/bag) - Yellow	40'	25.00 lbs

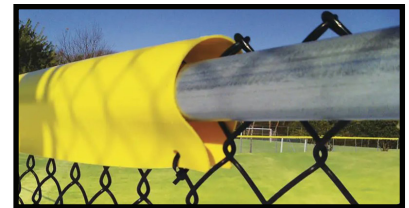

## Slat - Channel Only

CAD Item #	US Item #	Description	Weight
C.T.O.	SLCHL (XX)	Channel for Slats	0.50 lbs

## 1/8" CableRail (4 1/4" Terminal-Metal, 7 1/2" Terminal-Wood)

CAD Item #	US Item #	Description	Length
C.T.O.	CR005MTL	5ft - 1/8" Standard Cable Assembly for Metal	5'
C.T.O.	CR010MTL	10ft - 1/8" Standard Cable Assembly for Metal	10'
C.T.O.	CR015MTL	15ft - 1/8" Standard Cable Assembly for Metal	15'
C.T.O.	CR020MTL	20ft - 1/8" Standard Cable Assembly for Metal	20'
C.T.O.	CR025MTL	25ft - 1/8" Standard Cable Assembly for Metal	25'
C.T.O.	CR030MTL	30ft - 1/8" Standard Cable Assembly for Metal	30'
C.T.O.	CR040MTL	40ft - 1/8" Standard Cable Assembly for Metal	40'
C.T.O.	CR050MTL	50ft - 1/8" Standard Cable Assembly for Metal	50'
C.T.O.	CR005WOOD	5ft - 1/8" Standard Cable Assembly for Wood	5'
C.T.O.	CR010WOOD	10ft - 1/8" Standard Cable Assembly for Wood	10'
C.T.O.	CR015WOOD	15ft - 1/8" Standard Cable Assembly for Wood	15'
C.T.O.	CR020WOOD	20ft - 1/8" Standard Cable Assembly for Wood	20'
C.T.O.	CR025WOOD	25ft - 1/8" Standard Cable Assembly for Wood	25'
C.T.O.	CR030WOOD	30ft - 1/8" Standard Cable Assembly for Wood	30'
C.T.O.	CR040WOOD	40ft - 1/8" Standard Cable Assembly for Wood	40'
C.T.O.	CR050WOOD	50ft - 1/8" Standard Cable Assembly for Wood	50'



## CableRail Accessories & Tools

CAD Item #	US Item #	Description	Colour
C.T.O.	CR038BVWS	3/8" id Stainless Steel Beveled Washers	Stainless Steel
C.T.O.	CR932BVWS	9/32" id Stainless Steel Beveled Washers	Stainless Steel
C.T.O.	CRENDCPSS(C)	CableRail Stainless Steel Caps (C)Crown	Stainless Steel
C.T.O.	CRENDCPSS(D)	CableRail Stainless Steel Caps (D)Dome	Stainless Steel
C.T.O.	CRENDCAP(BK)	CableRail End Cap (BK) Black	Black
C.T.O.	C.T.O.	CableRail End Cap (BN) Brown	Brown
C.T.O.	CRENDCAP(BZ)	CableRail End Cap (BZ) Bronze	Bronze
C.T.O.	CRENDCAP(GY)	CableRail End Cap (GY) Grey	Grey
C.T.O.	C.T.O.	CableRail End Cap (WH) White	White
C.T.O.	CRRUBGROM	Rubber Grommets for 1/8" Cable	
C.T.O.	TLCB018RELS	Cable Release Tool 1/8"	
C.T.O.	TLCB316RELS	Cable Release Tool 3/16"	

Beveled Washers



Rubber Grommets



Cable Release Tool



# PRO LINK SUPPLY

## Tools

---



## STOCKade Products

CAD Item #	US Item #	Description	Weight	#/Box	#/P
60100	TLST400CFPS	STOCKade ST4iNA2 - ST400i 9ga Cordless Fencing Stapler	17.65 lbs	1	12
60101	AGST200PSTP	STOCKade SS4i50 - 2" 9ga Staple/Fuel Pack	22.04 lbs	1000	96
60102	AGST134CSTP	STOCKade SS4i45 - 1 3/4" 9ga Staple/Fuel Pack	22.04 lbs	1000	96
60103	AGST112CSTP	STOCKade SS4i40 - 1 1/2" 9ga Staple/Fuel Pack	17.08 lbs	1000	96
60104	TLST400PFSG	STOCKade A12605 - ST400 9ga Pneumatic Fencing Stapler	20.00 lbs	1	12
60105	AGST112PSTP	STOCKade SS4P40 - 1 1/2" 9ga Staples	17.08 lbs	1000	120
60106	AGST134PSTP	STOCKade SS4P45 - 1 3/4" 9ga Staples	22.04 lbs	1000	120
60107	AGST200PSTP	STOCKade SS4P50 - 2" 9ga Staples	22.04 lbs	1000	120
60108	TLST315CFST	STOCKade A12315 - ST315i 10.5ga Cordless Stapler	14.55 lbs	1	12
60109	TLST315STAP	STOCKade SS3i40B - 1 1/2" 10.5ga Staples	18.51 lbs	2100	140
60110	TLSTMRT	STOCKade A10855 - Ringfast Manual Tool	1.15 lbs	1	N/A
60111	FGSTMRG	STOCKade A10861 - Standard Ring Fasteners	2.20 lbs	1	100
60112	TLSTPRT	STOCKade A10871 - Ringfast A515 Tool	3.09 lbs	1	10
60113	FGSTPRG	STOCKade A10875 - Ringfast Clips	1.54 lbs	1000	100
60114	TLSTSMATET	STOCKade A12506 - STAPLEmate Fencing Pliers	1.79 lbs	1	N/A



The ST400i drives 4mm diameter barbed post staples reliably and consistently, making fence construction more efficient, delivering productivity gains for farmers and fencing contractors. The advanced fuel injection system delivers optimal fuel dose every time, driving at a rate of 2 staples/second. The sequential trigger system provides accurate staple placement and improved operator safety so you can work with speed and confidence.



Fast reliable, and relatively effortless, the pneumatic Ringfast ringing tool produces fast, consistent rings, reducing manual effort and improving productivity. Designed with an ergonomic grip and balanced for comfortable operation, it comes fully equipped for use; just connect one of your hoses to the Ringfast tool and the other to the compressor.

## Cement Products

CAD Item #	US Item #	Description	Type	Weight	#/Box
C.T.O.	CM060CON	Concrete Mix - 60 lb Bag	Standard	60.00 lbs	56
C.T.O.	CMPORTLAND	Portland Cement - 94 lb Bag	Portland	94.00 lbs	35
C.T.O.	CMREADYSET	Readysset - 50 lb Pail	Readysset	50.00 lbs	36
C.T.O.	CMQUICKSET	Quickset - 50 lb Bag	Quickset	50.00 lbs	56
C.T.O.	CMQUIKR	Quik-Rok	Quik-Rok	52.50 lbs	27



## Post Pounders & Drivers

CAD Item #	US Item #	Description	Weight	Unit
18628	TLPOUNDSML	Small (T Post) Pounder	40.00 lbs	Each
18630	TLPOUNDMED	4 1/2" x 24" Medium Post Pounder	50.00 lbs	Each
18632	TLPOUNDLRG	6 5/8" x 24" Large Post Pounder	55.00 lbs	Each
C.T.O.	TL0016POST	40 lb Post Driver	40.00 lbs	Each
C.T.O.	TL0026POST	50 lb Post Driver	50.00 lbs	Each



## Pliers

CAD Item #	US Item #	Description	Length	Weight	Type
C.T.O.	TL008RNDP	8" Round Nose Fence Pliers	8"	2.00 lbs	Round Nose
C.T.O.	TL010RNDP	10" Round Nose Fence Pliers	10"	2.00 lbs	Round Nose
C.T.O.	TL008CRES	8" Crescent Square Nose Fence Pliers	8"	1.50 lbs	Crescent Nose
C.T.O.	C.T.O.	10" Crescent Square Nose Fence Pliers	10"	2.00 lbs	Crescent Nose
06252	TLH0GLG	Large Hog Ring Pliers		2.00 lbs	Hog Ring-Large
06254	TLH0GSL	Small Hog Ring Pliers		1.50 lbs	Hog Ring-Small

Hog Ring Pliers



Crescent (Left)  
Round (Right)



## Vogel Pipe Notchers

CAD Item #	US Item #	Description	Weight
C.T.O.	TL025VOGE	#25 Econo Arc-Fit Notcher	30.00 lbs
C.T.O.	TL1400VOGE	#1400 Hand Press w/o Handle	35.00 lbs
C.T.O.	TL2500CPSA	2500-CSP-SA Hydraulic Cage Style Power Unit	275.00 lbs
C.T.O.	TL035VOGE	#35 Standard Housing	10.00 lbs
C.T.O.	TLVOGELTHT	Vogel Triple Housing Turntable CSP-TBT	125.00 lbs



## Pullers/Stretchers

CAD Item #	US Item #	Description	Weight
06256	TLWIREDOGS	Maasdam Wire Dog	3.00 lbs
C.T.O.	TLPULJA	A-2.5 Pul-Jak	20.00 lbs
06260	TLPULJB	B-2-2-1/2 Pul-Jak	20.00 lbs
C.T.O.	TLPULJC	C-2-1/2 Reverse Pul-Jak	20.00 lbs
06262	TLPULJREPK	Pul-Jak Repair Kit	12.00 lbs
06258	TLCABLEPUL	Cable Pow'R-Pull (Maasdam)	12.00 lbs
C.T.O.	TLSTRAPPUL	Strap Pow'R-Pull (Maasdam)	12.00 lbs
C.T.O.	TLFENCESTR	Fence Stretcher	12.00 lbs
C.T.O.	TLCLFENSTR	Chain Link Stretching Bar	17.00 lbs
C.T.O.	TLGATESTRH	Gate Stretcher	1.87 lbs

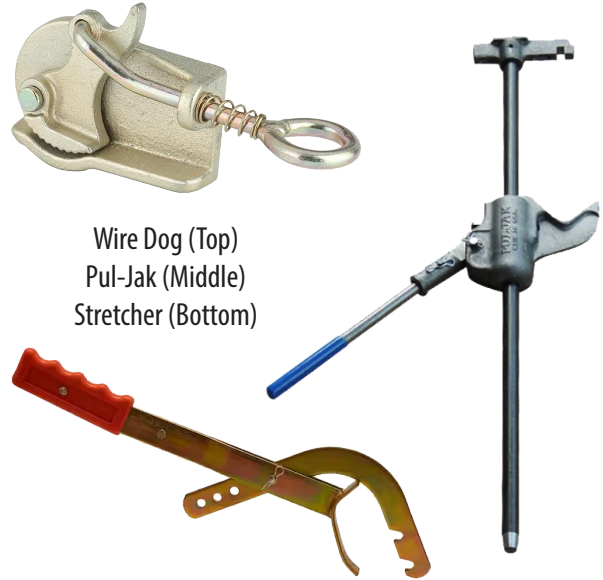

Wire Dog (Top)  
Pul-Jak (Middle)  
Stretcher (Bottom)

## Shovels/Diggers

CAD Item #	US Item #	Description	Weight
C.T.O.	TLFTSHV	Flat Head Shovel	8.00 lbs
C.T.O.	TLRDSHV	Round Head Shovel	8.00 lbs
C.T.O.	TL172HXDG	1" x 72" Hex Digger Bar	17.00 lbs
06268	TLPERFEWHD	Perfection Wood Handle Digger	15.00 lbs
06270	TLWODRH	Wood Replacement Handle	5.00 lbs
06266	C.T.O.	1 1/4" x 72" Round Digger Bar	12.00 lbs



Digger Bar (Left)  
Perf Digger (Middle)  
Flat Head (Right)

## Collins E-Z Cutter®

CAD Item #	US Item #	Description	Weight
C.T.O.	TLEZCUTTER	Collins Electric E-Z Pipe Cutter	121.00 lbs
C.T.O.	TLEZCBLADE	Collins E-Z Cutter Replacement Blade	1.00 lbs
C.T.O.	TLEZCFTSWI	Collins E-Z Cutter Foot Switch	5.50 lbs



## Questions? Comments?

---

**Please reach out to your nearest branch:**

ProLink Supply Ltd.  
23416 River Road  
Maple Ridge, B.C. V2W 187  
mapleridge@prolinksupply.com  
(604) 466-8839

ProLink Supply Inc.  
8100 Tacoma Mall Blvd  
Tacoma, Washington 98499  
sales@prolinksupply.com  
(253) 244-7082

ProLink Idaho LLC  
1412 Freedom Ave Ste B  
Caldwell, Idaho 83605  
caldwell@prolinksupply.com  
(208) 776-5465

ProLink Oregon LLC  
1885 16th Street SE  
Salem, Oregon 97302  
salem@prolinksupply.com  
(503) 990-6455



### **HOURS OF OPERATION**

March through November:  
Monday through Friday 7:00 am to 4:30 pm.

December through February:  
Monday through Friday 7:30 am to 4:00 pm.

Times subject to change.